

# FINAL REPORT

## Geophysical System Verification (GSV): A Physics-Based Alternative to Geophysical Prove-Outs for Munitions Response

Addendum - September 24, 2015

July 2009

Herb Nelson,  
ESTCP

Katherine Kaye,  
ESTCP Support Office, HydroGeoLogic, Inc.

Anne Andrews,  
ESTCP



Environmental Security Technology  
Certification Program



**REPORT DOCUMENTATION PAGE**

*Form Approved  
OMB No. 0704-0188*

The public reporting burden for this collection of information is estimated to average 1 hour per response, including the time for reviewing instructions, searching existing data sources, gathering and maintaining the data needed, and completing and reviewing the collection of information. Send comments regarding this burden estimate or any other aspect of this collection of information, including suggestions for reducing the burden, to the Department of Defense, Executive Services and Communications Directorate (0704-0188). Respondents should be aware that notwithstanding any other provision of law, no person shall be subject to any penalty for failing to comply with a collection of information if it does not display a currently valid OMB control number.

**PLEASE DO NOT RETURN YOUR FORM TO THE ABOVE ORGANIZATION.**

<b>1. REPORT DATE (DD-MM-YYYY)</b> 15-07-2009	<b>2. REPORT TYPE</b> Final Report	<b>3. DATES COVERED (From - To)</b> July 2009
--	---------------------------------------	--

<b>4. TITLE AND SUBTITLE</b> GEOPHYSICAL SYSTEM VERIFICATION (GSV): A PHYSICS-BASED ALTERNATIVE TO GEOPHYSICAL PROVE-OUTS FOR MUNITIONS RESPONSE	<b>5a. CONTRACT NUMBER</b> N/A
	<b>5b. GRANT NUMBER</b> N/A
	<b>5c. PROGRAM ELEMENT NUMBER</b> N/A

<b>6. AUTHOR(S)</b> Herb Nelson, ESTCP Katherine Kaye, ESTCP Support Office, HydroGeoLogic, Inc. Anne Andrews, ESTCP	<b>5d. PROJECT NUMBER</b> N/A
	<b>5e. TASK NUMBER</b> N/A
	<b>5f. WORK UNIT NUMBER</b> N/A

<b>7. PERFORMING ORGANIZATION NAME(S) AND ADDRESS(ES)</b> SERDP/ESTCP Program Office 901 North Stuart Street, Suite 303 Arlington, Virginia 22203	<b>8. PERFORMING ORGANIZATION REPORT NUMBER</b> N/A
--	--

<b>9. SPONSORING/MONITORING AGENCY NAME(S) AND ADDRESS(ES)</b> SERDP/ESTCP Program Office 901 North Stuart Street, Suite 303 Arlington, Virginia 22203	<b>10. SPONSOR/MONITOR'S ACRONYM(S)</b> SERDP/ESTCP
	<b>11. SPONSOR/MONITOR'S REPORT NUMBER(S)</b> N/A

<b>12. DISTRIBUTION/AVAILABILITY STATEMENT</b> Unlimited distribution
--

<b>13. SUPPLEMENTARY NOTES</b>
--------------------------------

<b>14. ABSTRACT</b> This document highlights a more rigorous physics-based alternative to geophysical prove-outs (GPO): Geophysical System Verification (GSV). Over the last 15 years, numerous GPOs have been performed and a significant body of knowledge has accumulated documenting technology performance. This accumulated understanding, along with the recognition that responses of munitions may be reliably predicted from physical models, presents the opportunity for both streamlining and enhancing the traditional GPO with a more rigorous physics-based approach. This document describes the physics basis of this evolution, outlines key elements of the GSV including an instrument verification strip and a blind seeding program, and presents an example of implementing this approach on a hypothetical site.
--

<b>15. SUBJECT TERMS</b> Munitions, Geophysical Prove-Outs, Geophysical System Verification
--

<b>16. SECURITY CLASSIFICATION OF:</b>	<b>17. LIMITATION OF ABSTRACT</b> UU	<b>18. NUMBER OF PAGES</b> 74	<b>19a. NAME OF RESPONSIBLE PERSON</b> Herb Nelson	
<table border="1" style="width:100%; border-collapse: collapse;"> <tr> <td style="width:33%; padding: 2px;"><b>a. REPORT</b> U</td> <td style="width:33%; padding: 2px;"><b>b. ABSTRACT</b> U</td> <td style="width:33%; padding: 2px;"><b>c. THIS PAGE</b> U</td> </tr> </table>			<b>a. REPORT</b> U	<b>b. ABSTRACT</b> U
<b>a. REPORT</b> U	<b>b. ABSTRACT</b> U	<b>c. THIS PAGE</b> U		



# TABLE OF CONTENTS

	<b>Page</b>
<b>EXECUTIVE SUMMARY</b> .....	vii
<b>ACKNOWLEDGMENTS</b> .....	ix
<b>1.0 INTRODUCTION</b> .....	<b>1</b>
1.1 Beyond GPOs.....	1
1.2 Background-The Munitions Response Problem and Process .....	3
1.3 Evolution of the GPO.....	3
1.4 Limitations of GPOs .....	5
1.5 Physics-Based Geophysical System Verification .....	6
1.6 About This Report.....	8
<b>2.0 PHYSICS BASIS FOR GEOPHYSICAL SYSTEM VERIFICATION</b> .....	<b>9</b>
2.1 Sensor Response Curves .....	9
2.1.1 Industry Standard Objects.....	10
2.1.2 Munitions .....	12
2.2 Noise .....	13
2.3 Considerations for Interpreting Measurements.....	14
2.3.1 Uncertainty in Burial Location .....	15
2.3.2 Along-Track Offset.....	15
2.3.3 Target Orientation .....	16
2.3.4 Remanent Magnetization .....	17
2.3.5 Error Bars.....	17
2.4 Applying Response Curves to Anomaly Selection Criteria.....	18
<b>3.0 INSTRUMENT VERIFICATION STRIP</b> .....	<b>21</b>
3.1 Specifying the IVS.....	21
3.1.1 IVS Items and Placement.....	21
3.1.2 Noise Measurements .....	22
3.2 Data Collection .....	22
3.3 Data Analysis and Interpretation .....	24
<b>4.0 BLIND SEEDING IN THE PRODUCTION SITE</b> .....	<b>27</b>
4.1 Specifying the Seed Plan .....	27
4.1.1 Selecting the Seed Targets.....	27
4.1.2 Quantity, Depth and Orientation.....	28
4.1.3 Emplacement.....	28
4.1.4 Custody of Information.....	29
4.2 What Data are Taken and How are They Evaluated? .....	29
4.3 What is the Product? .....	29
<b>5.0 DISCUSSION</b> .....	<b>33</b>
5.1 Meeting the Historical Objectives of GPOs.....	33
5.2 Added Benefits of GSV .....	37

## TABLE OF CONTENTS (continued)

		<b>Page</b>
6.0	REFERENCES .....	39
APPENDIX A	Application to an Example Site	
APPENDIX B	Frequently Asked Questions	
ADDENDUM	Geophysical System Verification (GSV): A Physics-Based Alternative To Geophysical Prove-Outs for Munitions Response - September 24, 2015	

## LIST OF FIGURES

	<b>Page</b>
Figure ES-1. EM61-MK2 response curve (time gate 2) for the small ISO.....	viii
Figure 1-1. Evolution of Geophysical Prove-Out to Geophysical System Verification.....	2
Figure 2-1. Industry Standard Objects.....	11
Figure 2-2. EM61-MK2 response curve (time gate 2) for the small ISO.....	12
Figure 2-3. EM61-MK2 response curve (time gate 2) and total field magnetometer response curve for a 4.2-inch mortar. ....	13
Figure 2-4. Example of signal plus noise traces—(a) 60-mm mortar, (b) 37-mm projectile, (c) 20-mm projectile .....	14
Figure 2-5. Anomaly amplitude as a function of cross-track position for a 37-mm projectile horizontal, along-track 50 cm below the coil of an EM61-MK2.....	15
Figure 2-6. Anomaly amplitude as a function of cross-track position for an item in two orientations under an EM61-MK2 .....	16
Figure 2-7. Magnitude and direction of the primary field generated by an EM61-MK2 as a function of depth and cross-track distance .....	17
Figure 2-8. Variability in the expected sensor response caused by error in the target burial depth .....	18
Figure 3-1. Required data collection on the IVS .....	23
Figure 3-2. Optional additional data collection on the IVS.....	23
Figure 3-3. EM61-MK2 response curve (time gate 2) for the small ISO.....	24
Figure 3-4. Daily signals recorded for a small ISO at a depth of 11 cm in its least favorable orientation .....	25
Figure 3-5. Noise trace for gate 2 of an EM61 .....	25
Figure 4-1. Signal strength of seed targets compared to sensor response curve .....	30
Figure 4-2. Location accuracy of seed targets.....	30
Figure 4-3. Failure analysis of a seed that was not selected as a target.....	31
Figure A-1. Predicted EM61-MK2 gate 2 response of a 37-mm projectile and a 3-lb practice bomb.....	A-2
Figure A-2. Anomaly amplitude as a function of cross-track position for an item under an EM61-MK2.....	A-2
Figure A-3. Sketch of the IVS layout for the example site .....	A-4
Figure A-4. Sketch of the survey protocol for the first data collection at the IVS.....	A-4

## LIST OF FIGURES (continued)

	<b>Page</b>
Figure A-5. Measured data from the line passing directly over the IVS items .....	A-5
Figure A-6. Measured data from the line offset 2 m from the IVS items .....	A-5
Figure A-7. Calculated response in gate 2 of an EM61-MK2 for a 37-mm projectile in its most and least favorable orientations, the survey noise measured at the site, the signal measured over the two projectiles in the IVS, and an indication of the depth of interest for this item at this site.....	A-6
Figure A-8. Plot of the deviations in positions of the six IVS items, as determined from the profile shown in Figure A-5 from the known positions.....	A-7
Figure A-9. Interpolated anomaly image constructed using the data from the passes with offsets of -60, 0, and 60 cm .....	A-7
Figure A-10. Plot of the deviations in the fitted positions of the six IVS items from the known positions .....	A-8
Figure A-11. Sketch of the survey protocol for the twice daily performance confirmation surveys at the IVS. ....	A-9
Figure A-12. Twice daily variation of down-track position for the items in the IVS .....	A-10
Figure A-13. Twice daily variation of measured signal amplitude for the targets in the IVS .....	A-11
Figure A-14. Cumulative plot of anomaly amplitude for seeds encountered in the survey ...	A-13
Figure A-15. Cumulative plot of location accuracy for seeds encountered in the survey.....	A-13



## LIST OF TABLES

	<b>Page</b>
Table 2-1. Industry standard objects characterized for use as munitions surrogates .....	11
Table 3-1. Example lateral offsets between the target IVS and noise strip for a magnetometer and EM61-MK2 .....	22
Table 5-1. Typical objectives of GPOs .....	34
Table 5-2. Summary of Recommended QC Enhancements for GSV .....	37
Table A-1. Data objectives for the example site .....	A-1
Table A-2. Instrument verification strip definition for the example site .....	A-3
Table A-3. Comparison of peak gate 2 response directly over the 37-mm projectiles to those offset by 30 cm in the cross-track direction .....	A-8



## EXECUTIVE SUMMARY

---

The evaluation and cleanup of current and former military sites contaminated with buried munitions relies on two well-understood geophysical technologies to detect the munitions: magnetometry and electromagnetic (EM) induction. As these technologies were introduced in munitions response projects, the Geophysical Prove-Out (GPO) was developed to provide proof that the geophysical data collected would meet project objectives. Over the last 15 years, numerous GPOs have been performed on a variety of site conditions, and a significant body of knowledge has accumulated documenting the performance of these technologies. This accumulated understanding, along with the recognition that magnetic and EM responses of munitions may be predicted reliably using physical models, presents the opportunity for both streamlining and enhancing the GPO with a more rigorous physics-based approach.

A Geophysical System Verification (GSV) process is envisioned in which the resources traditionally devoted to a GPO are reallocated to support simplified, but more rigorous, verification that a geophysical system is operating properly, as well as ongoing monitoring of production work. Two main elements are considered in this document:

- **Instrument Verification Strip:** The GPO, which consists of several tens to a hundred or more targets, would be replaced by an instrument verification strip (IVS) containing a handful of targets. The objective of the IVS would be to verify that the geophysical detection system is operating properly. The IVS targets should be observed in the data with signals that are consistent with both historical measurements and physics-based model predictions. Adjacent measurements of the site noise would determine whether targets of interest can be detected reliably to their depth of interest under the site conditions.
- **Blind Seeding Program:** Blind seeding in the production site is an integral part of this concept. The production site would be seeded with targets at surveyed locations that are blind to the data collection and processing teams. The objective of the seed program would be to provide ongoing monitoring of the quality of the geophysical data collection and target selection process as it is performed in the production survey throughout the project. The blind seeds should be numerous enough to be encountered on a daily basis, should be selected as potential targets, and their signals should be consistent with both historical measurements and physics-based model predictions.

In addition, this process envisions enhanced quality monitoring of geophysical data to ensure that the historical GPO objectives not directly addressed by the GSV are still met.

Both the IVS and the seeds rely on the availability of well-characterized targets. In this role, we propose the use of an “industry standard object” (ISO). We have selected and characterized three sizes of commonly available pipe sections that can be obtained from plumbing or hardware suppliers. While munitions may vary by make and model number (i.e., there are many different types of 60-mm mortar), ISOs have the advantage that they will be made to the same specification regardless of where they are obtained. Together, the three sizes should meet the objectives of most munitions response projects.

Sensor response is characterized using models developed to interpret data from the Geonics EM61-MK2 electromagnetic induction sensor and the various magnetometers. Blind tests have validated the models and they can now be used to predict confidently the sensor response to a target of interest to produce “sensor response curves” plotting signal strength versus depth. Response curves have been calculated to characterize the three ISOs, as well as a number of common munitions, and corresponding verification measurements performed. An example of the response curve for the small ISO for an EM61-MK2 is shown in Figure ES-1. This family of curves can be used in the IVS and the seed program to quantitatively verify that the geophysical system is detecting the items at the expected signal levels. As next generation sensors become available, similar response curves can be generated.

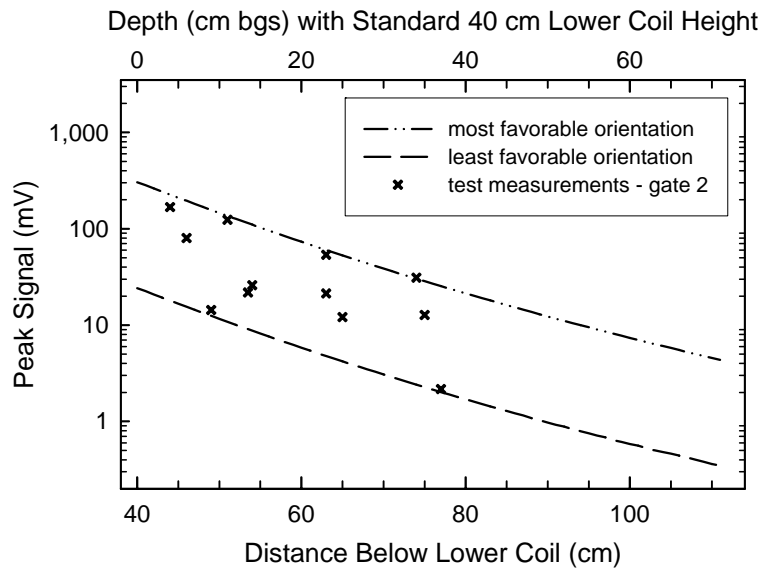

**Figure ES-1. EM61-MK2 response curve (time gate 2) for the small ISO. Dashed lines are the modeled curves for the most and least favorable orientations. Measurements are for objects in a variety of depths and orientations and fall within the expected bounds of the upper and lower curves.**

The GSV proposed here will move resources from an up-front evaluation of the geophysical systems to an ongoing verification of the system performance. A physics-based approach reduces the logistical burden (e.g., multiple mobilizations, acquisition of surrogates) of the current process, allows use of a smaller plot of land, and results in greater confidence in the performance of the production geophysics and the success of the overall project. There are similarities between this approach and common environmental sampling quality procedures: using the IVS is comparable to running a known concentration sample for daily instrument checks and the blind seeds are comparable to blanks and matrix spikes.

## ACKNOWLEDGMENTS

---

In the preparation of this document, ESTCP solicited input from representatives of the services, state and federal regulators, and the National Association of Ordnance and Explosive Waste Contractors (NAOC). We acknowledge the contributions of the following individuals:

John Allan, NAOC  
James Austreng, California Department of Toxic Substances Control  
Thomas Bell, SAIC  
Geoffrey Carton, CALIBRE Systems, supporting the Office of the Deputy Assistant Secretary of the Army for Environment, Safety and Occupational Health Support  
Harry Craig, U.S. Environmental Protection Agency Region 10, Oregon Operations Office  
Timothy Deignan, NAOC  
Jonathan Haliscak, Air Force Center for Engineering and the Environment  
Tamir Klaff, NAOC  
Douglas Maddox, U.S. Environmental Protection Agency  
Douglas Murray, Naval Ordnance Safety and Security Activity  
Andrew Schwartz, U.S Army Corps of Engineers, Huntsville  
Jeffery Swanson, Colorado Department of Public Health and Environment  
Michael Tuley, Institute for Defense Analyses  
Guy Warren, Alaska Department of Environmental Conservation  
Roger Young, U.S. Army Corps of Engineers, Huntsville

ESTCP also thanks Daniel Steinhurst and Glenn Harbaugh from Nova Research, Inc. for collecting data to support the hypothetical site example presented in Appendix A.

## LIST OF ACRONYMS

---

ASTM	American Society for Testing and Materials
BGS	below ground surface
CERCLA COE	Comprehensive Environmental Response, Compensation and Liability Act Corps of Engineers
DoD DQO	Department of Defense data quality objectives
EM EMI ESTCP	electromagnetic electromagnetic induction Environmental Security Technology Certification Program
GPO GPS GSV	Geophysical Prove-Out global positioning system Geophysical System Verification
ISO ITRC IVS	industry standard object Interstate Technology Regulatory Council instrument verification strip
MR MTADS	munitions response Multi-sensor Towed Array Detection System
NAOC	National Association of Ordnance and Explosive Waste Contractors
QA QC	quality assurance quality control
RCRA RMS RTK	Resource Conservation and Recovery Act root mean square real-time kinematic
SNR	signal-to-noise ratio
UXO	unexploded ordnance

## DEFINITIONS

---

**Anomaly source resolution.** After an object is excavated, the geophysicist evaluates whether the recovered item is consistent with the corresponding geophysical anomaly. Inconsistencies between the object and the anomaly require additional investigation of the dig location to determine whether additional items remain.

**Blind seeding.** Targets buried on a production site at surveyed locations that are blind to the data collection and processing teams. Seeds provide ongoing monitoring of the quality of the geophysical data collection and target selection process as it is performed in the production survey throughout the project.

**Industry standard object.** Three sizes of commonly available schedule 40 pipe nipples, threaded on both ends, made from black welded steel, that have been modeled and measured. These pipe sections can serve as instrument verification strip targets and can be emplaced throughout the production site in a blind seeding program.

**Instrument verification strip.** A line of objects buried in a representative, open area convenient to the location where the geophysical survey equipment is set up or operated. The objective of the IVS is to verify that the geophysical detection system is operating properly at the beginning and end of each data collection day. The objects should be observed in the data with signals that are consistent with both historical measurements and physics-based model predictions. The IVS also serves to verify that the geo-location system provides accurate sensor location data.

**Geophysical System Verification.** A rigorous physics-based approach to streamline and enhance the geophysical prove-out. The primary elements of the GSV are an instrument verification strip and blind seeding the production site. This process provides ongoing monitoring of the quality of the geophysical data collection and target selection process as it is performed in the production survey.

**Noise strip.** A strip containing no discrete anomalies or non-representative terrain or geology that will affect the instrument. The noise strip should be located near the instrument verification strip and is used to check that the noise level of the instrument is what would be expected for that site and that system noise is consistent day to day.

**Presumptive technologies.** The capabilities and limitations of geophysical systems for detecting munitions based on common magnetometer and electromagnetic induction sensors are well understood. On many sites, this understanding provides an opportunity for site teams to presumptively select a geophysical technology as part of the planning process. The appropriateness of a presumptive technology can be verified by implementing the elements of the GSV. A presumptive technology is analogous to the Environmental Protection Agency's presumptive remedy, which is a technology that, based on past experience, generally will be the most appropriate remedy for a specific type of site.

**Root mean square (RMS) noise.** Standard deviation of the sensor readings not associated with a target.

**Sensor response curves.** The response of well-characterized geophysical systems to individual munitions and industry standard objects have been predicted using physics-based models and verified with measurements. Curves show the expected peak amplitude range for the target of interest at any given depth, bounded by the most and least favorable orientations. These curves can support the quantitative determination that a sensor is producing the expected signals in the instrument verification strip and blind seeding program. Further, in combination with measured site noise, they quantify the expected detection capability.

**Signal-to-noise ratio.** In the context of this report the signal-to-noise ratio, or SNR, is the maximum signal compared to the root mean square (RMS) noise level. The SNR can be used to determine the expected detection performance of a geophysical sensor. In general, an SNR of 3 to 5 is required for reliable detection.



# **GEOPHYSICAL SYSTEM VERIFICATION (GSV): A PHYSICS-BASED ALTERNATIVE TO GEOPHYSICAL PROVE-OUTS FOR MUNITIONS RESPONSE**

## **1.0 INTRODUCTION**

### **1.1 BEYOND GPOS**

The evaluation and cleanup of current and former military sites contaminated with buried munitions relies on two well-understood geophysical technologies to detect the munitions: magnetometry and electromagnetic (EM) induction. As these technologies were introduced in munitions response projects, the Geophysical Prove-Out (GPO) was developed to provide proof that the geophysical data collected would meet project objectives. Over the last 15 years, numerous GPOs have been performed on a variety of site conditions, and a significant body of knowledge has accumulated documenting the performance of these technologies. This accumulated understanding, along with the recognition that magnetic and EM responses of munitions may be predicted reliably using physical models, presents the opportunity for both streamlining and enhancing the GPO with a more rigorous physics-based approach. The method envisioned here will be applicable to any well-characterized and documented magnetometer or EM system. In this document, it is applied to the commonly used sensors of today, for which all necessary physical characterization data have been generated.

A Geophysical System Verification (GSV) process is envisioned in which the resources traditionally devoted to a GPO are reallocated as illustrated in Figure 1-1 to support simplified, but more rigorous, verification that a geophysical system is operating properly, as well as ongoing monitoring of production work. Two main elements are considered in this document:

- **Instrument Verification Strip (IVS):** The GPO, which consists of several tens to a hundred or more targets, would be replaced by an IVS containing a handful of targets. The objective of the IVS would be to verify that the geophysical detection system is operating properly. The IVS targets should be observed in the data with signals that are consistent with both historical measurements and physics-based model predictions.
- **Blind Seeding Program:** The production site would be seeded with targets at surveyed locations that are blind to the data collection and processing teams. The objective of the seed program would be to provide ongoing monitoring of the quality of the geophysical data collection and target selection process as it is performed in the production survey throughout the project. Ideally, the blind seeds should be numerous enough to be encountered on a daily basis. They should be selected as potential targets and their signals consistent with both historical measurements and physics-based model predictions.

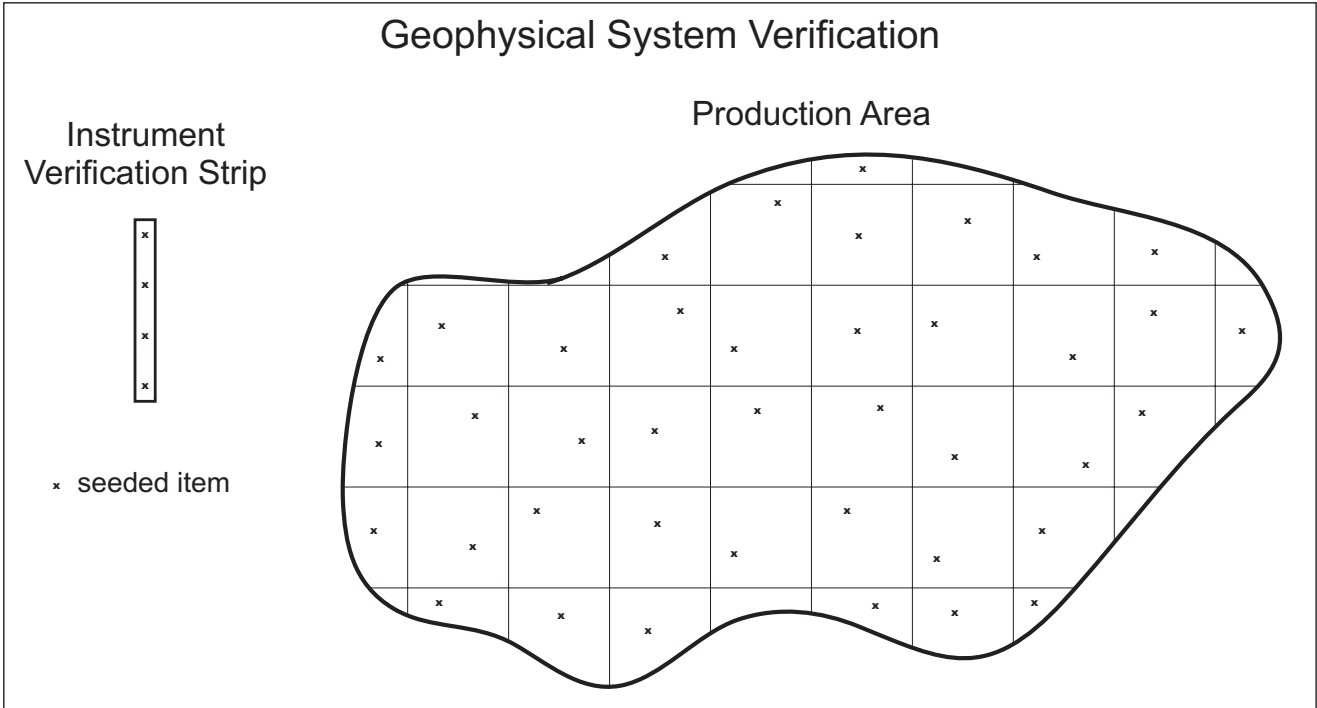
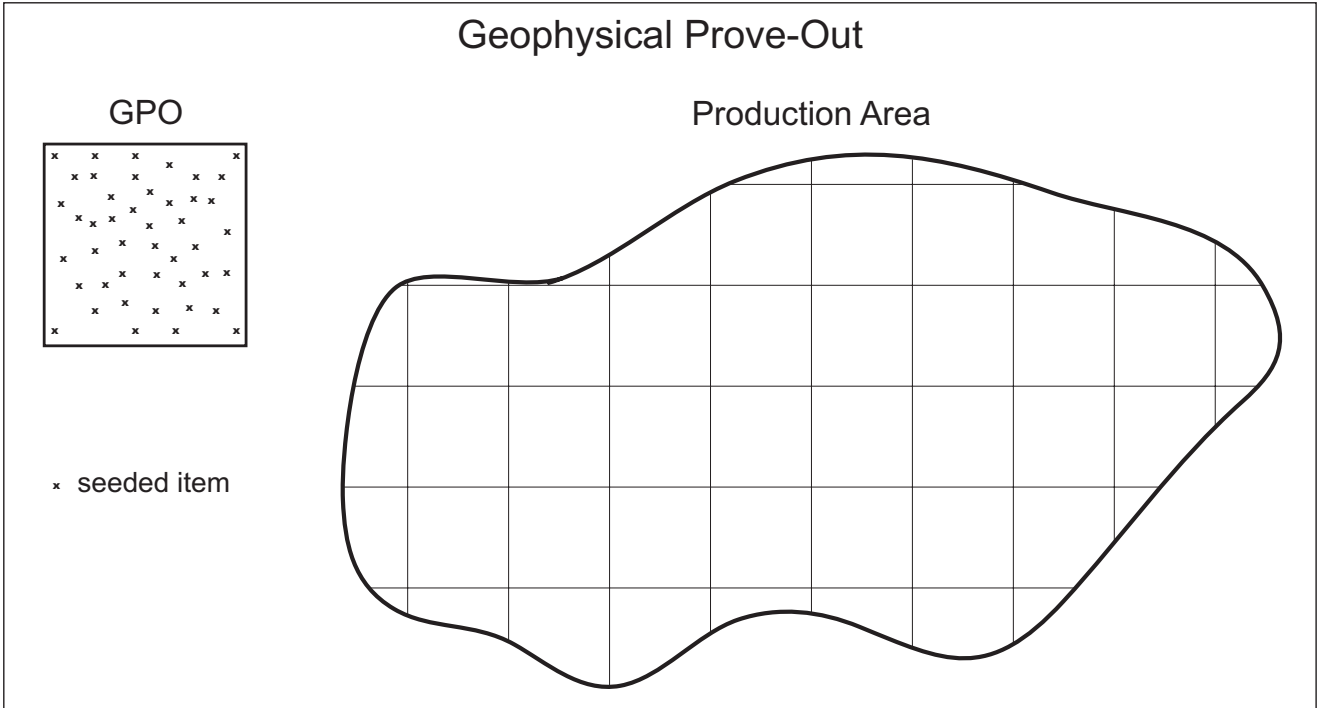

Figure 1-1. Evolution of Geophysical Prove-Out to Geophysical System Verification

There are similarities between this approach and common environmental sampling quality procedures: using the IVS is comparable to running a known concentration sample for daily instrument checks, and the blind seeds are comparable to blanks and matrix spikes. In addition, this process envisions enhanced quality monitoring of geophysical data to ensure that the historical GPO objectives not directly addressed by the GSV, such as qualifying contractors to begin production work, are still met.

## **1.2 BACKGROUND-THE MUNITIONS RESPONSE PROBLEM AND PROCESS**

The U.S. Department of Defense (DoD) has used thousands of locations in all 50 states to manufacture, test, or store military munitions, and to train military personnel in their use. When large numbers of explosively configured military munitions are used, some do not function as intended and present a lingering explosives safety hazard. Depending on the type of munition, its fuzing system, and various environmental factors, 1 to 30 percent of munitions employed fail to function properly (Ref. 1) and are called “unexploded ordnance,” “UXO,” “duds,” or similar terms. Such munitions can retain their capability to function for extremely long periods.

Today, DoD has effective procedures to control military lands containing UXO. However, this has not always been the case. Especially during the period immediately after WWII many military installations were quickly converted back to civilian use. Portions of installations containing UXO were typically subjected to a visual investigation, or “surface sweep” to locate and destroy munitions found on the ground surface, but such sweeps were imperfect and may have missed some of the items. In addition, it was beyond the technology of the day and prohibitively expensive to search, detect, and recover all the subsurface munitions, and so they largely remained in place.

In the decades of the 1980s and 1990s, three important events occurred which led to nationwide efforts to assess and respond to risks at sites containing UXO. First, two young boys in California were killed handling an unexploded round that they had found on a formerly used defense site, raising public awareness of the dangers of UXO. Second, environmental laws such as the Resource Conservation and Recovery Act of 1976 (RCRA) and the Comprehensive Environmental Response, Compensation and Liability Act of 1980 (CERCLA) were expanded to give federal and state regulatory agencies more authority to require the military services to address UXO sites no longer being used for military training. Third, new technology in the form of improved geophysical instruments and inexpensive desktop computers became widely available. As a result of the new requirement to better address explosives hazards from military munitions and the emergence of technologies to improve munitions detection, the military services began performing munitions responses at scales never before attempted.

## **1.3 EVOLUTION OF THE GPO**

During early attempts to use these new detection technologies, it became obvious that much remained to be learned. The first projects often began with a “test off” of multiple sensor types for each site. Detection technologies that worked well in one place seemed not to work at all in another. Results achieved by one team at a given location could not always be duplicated by another team at the same location using the same equipment. Most importantly, there was little information regarding what these first munitions responses were actually achieving: No one could say with much certainty how deeply or effectively the instruments were detecting

munitions, nor what was being left behind. In other words, there was no measured, quantitative method of describing the results of a munitions response.

As a result, DoD managers and state and federal regulators providing oversight to projects began looking for ways to quantitatively understand, measure, and describe the effectiveness of technologies used at UXO sites. They began to use GPOs in an attempt to determine the capabilities and limitations of geophysical systems under controlled conditions near the work site. In a GPO, a known number of inert munitions, surrogates, and other objects are buried at precisely known locations and depths, and then the site is mapped with one or more geophysical instruments. The data are processed and targets selected based on some predetermined criteria, and the resulting geophysical map is used to display “anomalies” that represent potential munitions. Performance on the GPO is scored primarily based on the fraction of the emplaced targets that are associated with geophysical detections, often accompanied by many other secondary metrics.

During this time, two main types of GPO plots emerged.

- Project GPOs. Site-specific GPOs have been constructed at hundreds of munitions response sites. While most are small, simple sites containing a few tens of items, some project GPOs are far more extensive and costly. Project GPOs are meant to be representative of the limited types of munitions expected at the site in question. These GPOs have been used initially to select geophysical equipment and then to test a geophysical system’s capabilities under site conditions. In addition, they offer a location for the detection teams to safely fine-tune their equipment, field procedures, and analysis methods.
- Research and Development GPOs. Large, complex sites with many different kinds of items buried at multiple depths and orientations have been operated mainly for research and development purposes. Beginning in 1993, such sites were used to measure and compare the capabilities of many different types of detection systems. Permanent standardized UXO technology demonstration sites have been established at Aberdeen Proving Ground and Yuma Proving Ground. These sites are periodically modified and used for years.

There now have been multiple tests of many geophysical systems at these two types of sites over a period of about 15 years, resulting in a vast increase in the understanding of the capabilities and limitations of common geophysical detection systems. The large experience base from GPOs has produced an understanding not only of the level of effectiveness that different geophysical systems are likely to achieve under differing site conditions but also of optimum ways to employ geophysical systems. (Ref. 2). This improved understanding of these technologies has resulted in the ability to specify data quality requirements for project objectives and identify presumptive technologies to meet those objectives, and the GPO can be used to document that they are being met.

Finally, among the most important conclusions of GPO testing is the fact that detection of buried munitions is highly dependent on the munitions’ size, composition, and depth of burial; the amount of geophysical “noise” at a site; and the skill of the operators and analysts. Even with a successful GPO, it is possible for munitions to remain at a site following a response action. Integrating the goals of the traditional project GPO with the quality assurance and quality control

aspects of the project offers the opportunity to better document performance throughout the investigation.

#### **1.4 LIMITATIONS OF GPOS**

The typical overarching objective cited for a GPO is to characterize the sensor system performance under site-specific conditions. Often, what this requires in terms of what is to be measured and how the measurements meet that overall objective is not fully explored or appreciated. The determination of site-specific performance has commonly been interpreted to mean using the percent of emplaced items detected as an estimate for the probability of detection that the system will achieve on the production site or determining the maximum achievable depth of detection. Although it is straightforward to calculate these metrics, few if any GPOs contain a sufficient number of target items to allow for statistically defensible estimates of their true values.

Other metrics that do not rely on establishing statistical significance can be measured more meaningfully. Some specific measurement objectives that can be addressed by a GPO include:

- verify signal levels,
- verify location and navigation accuracy or precision,
- measure noise,
- confirm anomaly selection criteria,
- evaluate contractor data analysis,
- ensure data compliance, and
- confirm instrument selection appropriateness.

All these metrics carry an assumption about representativeness; that is, an inherent assumption regarding GPOs is that conclusions drawn from performance in the GPO are applicable to work on the “live” production site. This requires that

- the population of targets and clutter placed in a GPO is representative of the actual target and clutter population that will be encountered in the field and
- the geophysical systems and processes employed at a GPO sufficiently resemble the geophysical systems and processes employed in the field.

In fact, the true distribution of targets and depths is unknown at the time the GPO is constructed and the resources available typically constrain the size of the GPO and number of targets that are emplaced. Many live sites are vastly heterogeneous across a wide range of variables, including target density, clutter environment, geology, and other noise sources. In practice, there is almost always significant discrepancy between the GPO and the live site it models.

In addition, the GPO survey likely represents ideal performance in many applications. The way in which a GPO is used has varied from one qualifying run at the beginning of a project to daily monitoring. This variability makes it difficult to generalize, but there are two common themes in the concerns have been raised over the years about how well performance on the GPO represents performance throughout the production work. First, often projects employ multiple crews with multiple instruments in production work, and it is rare for all teams and equipment to qualify

each day. If one team passes the GPO at the beginning of the project, no information is available on how that team performs weeks or months into the project, nor on how other teams perform. Second, the GPO is a small area where it is possible that the crew, motivated to “pass” the GPO, can be more careful than they might be throughout the site. Over time the GPO will become familiar to the crews, so any blind testing aspect is lost. Overall, the GPO provides little information on performance of the system or the crew while collecting production data.

Finally, in recent years the GPO has become, out of convenience, a catchall for a variety of tests and activities that are far outside its original purpose. These include contractor field-crew training, optimization of data collection procedures, and demonstration of anomaly reacquisition. While these activities are undoubtedly important for a quality project, there is nothing unique about a GPO that supports their performance. Indeed, these activities may drive the design and construction of the GPO when they either ought to or could, in fact, be better performed by the contractor prior to arrival or by quality monitoring during the production work.

## 1.5 PHYSICS-BASED GEOPHYSICAL SYSTEM VERIFICATION

The intent of the GSV concept is to introduce a more rigorous, transparent, timely, and cost-effective process, while ensuring that no critical historical GPO functions are lost. We begin with the primary objective of characterizing site-specific performance. This encompasses many of the other GPO objectives, including measuring site-specific probability of detection, measuring achievable depth of detection, verifying signal levels, and measuring site noise. We have already established that GPOs do not allow the determination of the first two of these, which are empirical, statistically dependent metrics, so we will concentrate on verifying signal levels and measuring site noise, both of which are necessary and sufficient to determine expectations for how a system will perform on a site. Specifically, the information required to confirm system performance and ensure that the data quality objectives (DQO) can be met at the site is quite limited when viewed in context of the historic GPO. The requirements are basically to

- verify that the geophysical system is performing correctly by measuring the sensor responses of a small number of well-characterized items and confirming that the responses lie within expected parameters (and that the measured locations of the detected items are within requirements) and
- measure the site noise and determine whether targets of interest can be detected reliably to their depth of interest under the site conditions present.

Both requirements may be met on a modest sized test strip of known, well-characterized objects. The essential elements required for the necessary quantitative measurements include:

- *Well-characterized sensor.* The premise of this approach is that the basic physics of the sensor system is well characterized and documented. Magnetic signatures of items do not vary from one sensor to another, although how the magnetic field is measured differs. Prediction of EM signatures requires knowledge of salient features of the sensors, such as the transmit moment, coil geometry, and receive time gates, which are well-documented for the commonly used EM61-MK2. The GSV may, in principle, be applied to any variation on EM technology that is transparent and documented.

GSV will not be applicable to so-called “black boxes.” This will include proprietary devices for which sensor details are not divulged and any other system whose operation, in terms of both hardware and processing, is not well-documented. Nor will it be appropriate for technologies based on completely different physical phenomena, where a GPO may be required.

- *Well-characterized test objects.* EM and magnetic signals are site invariant and any well-characterized object may be used for GSV. Test objects may include the munitions of interest, but that is not essential for confirming that the system is operating properly. As an alternative, we introduce the concept of an “industry standard object” (ISO). We have selected three sizes of commonly available pipe sections that can be readily obtained from any plumbing or hardware supplier. While munitions may vary by make and model number (i.e., there are many different types of 60-mm mortars), ISOs have the advantage that they will be made to the same specification regardless of where they are obtained. Together, the three sizes should meet the objectives of most munitions response (MR) projects in that the physics characteristics of one or more of the ISOs will be sufficiently similar to the targets of interest that they can be used to verify that the system is operating properly and can be expected to detect the targets of interest.

The ISOs have been modeled and measured so that they can serve as well-characterized IVS targets. (Ref. 3) Similar data are provided for commonly encountered munitions. (Ref. 4) The data are included in the CD that accompanies this report to allow application to single-sensor EM61-MKII and magnetometer systems. A simple Windows application is provided that can be used to produce sensor responses for any array arrangement of an EM61.

- *Digital data collection.* The physics-based approach relies on the ability to demonstrate that a measured signal for a known object is consistent with physical model predictions and prior measurements, and further that the signal is detectable above measured site noise. Both of these factors require a digital record of geolocated instrument readings. Approaches such as mag and dig, which rely on an operator making a real-time decision interpreting an analog signal, do not produce such a record. Although some aspects of this approach may be transferable to projects based on analog technologies, care should be taken, as it was not conceived with such methods in mind.

Equally important to confirming that the sensor system can be expected to meet project objectives based on test strip results is confirming that the production geophysics is conducted in such a way to accomplish the same performance in the field. ISOs, which can be readily obtained cheaply and in large quantities, can be emplaced throughout the production site in a blind seeding program. If the objects chosen meet target selection criteria, the seeds can serve as an ongoing check of the production work.

The GSV is an end-to-end approach that can be directly applied to most sites, but it is easy to conceive of situations in which elements will be impractical and some modification will be required. The test strip concept can be used to verify instrument performance on any site and is an integral part of quality monitoring. For very large sites, it may be cost effective to construct multiple replications of the test strip so that crews can conduct their daily checks without undue

transit time. Some aspects of the seeding discussed here will not be practical at all sites. For example, seeds may be difficult to apply to transects and meandering path surveys, where 100% survey coverage is not required and the exact locations of survey lines is not known in advance. At a site where the primary munitions of interest are deeply buried large bombs, it will not be cost effective to bury comparably sized objects to depth in great quantities. Although an ISO may not be available to replicate a bomb signature consistent with target selection criteria, the ISOs can still be used to specify a quantitative verification test of essential system parameters.

## **1.6 ABOUT THIS REPORT**

In this report, we present a concept for moving beyond GPOs. Our intended audience is the contractor community, project managers, regulators, and others who share decisions on how MR projects are implemented. It is assumed that readers possess an undergraduate education in a science or engineering field, or equivalent experience, and are familiar with the basic MR processes.

Section 2 summarizes the physical justification for the proposed approach. In Sections 3 and 4, we discuss the specifics of the test strip and the blind seed program. Section 5 addresses GPO objectives and how they may be achieved within the GSV framework, including the enhanced quality monitoring program envisioned, as well as added benefits. Appendix A provides an end-to-end illustration of how this approach might be implemented on an example site. Appendix B is a series of frequently asked questions and answers. The report is accompanied by a CD containing characterization measurements and model fit response curves for the ISOs and a selection of common munitions to support use with EM61-MK2 and magnetometer-based systems, as well as a simple Windows application for computing sensor response curves for EM61 arrays.

The recommendations in this report represent what is necessary from a technical viewpoint to validate the equipment and procedures. We discuss a bare minimum that will be technically acceptable, but the authors recognize that GPOs have also been used to provide the regulators and public a sense of comfort, for example, with data that demonstrates that a given system detects specific munitions of concern to a specific depth. While not strictly necessary, the inclusion of such items may continue to be advantageous for purposes of communication and acceptance. Some examples are discussed.

The GSV proposed here will move resources from an up-front evaluation of the geophysical systems and their performance to an ongoing verification of the system performance. Utilizing a physics-based approach reduces the logistical burden (e.g., multiple mobilizations, acquisition of surrogates) of the current process, allows use of a smaller plot, and results in greater confidence in the performance of the geophysical project itself.



## **2.0 PHYSICS BASIS FOR GEOPHYSICAL SYSTEM VERIFICATION**

The GSV relies on a few key physical concepts. In this section, we summarize these concepts, discuss methods and supporting measurements, and explain how the data can be interpreted and used in the GSV. Details may be found in the referenced reports. A cornerstone of the GSV is a predictable and verified signal for an item of interest. The signal strength, combined with site-specific noise measurements, will determine what the sensor can and cannot detect reliably under specific site conditions. Decisions based on quantitative interpretation of signal and noise measurements will require accounting for uncertainties in these quantities, which are also discussed.

### **2.1 SENSOR RESPONSE CURVES**

Over the past 10 years, ESTCP has supported a number of groups to develop models to interpret data from the Geonics EM61-MK2 electromagnetic induction sensor and various magnetometers. Blind tests have validated the models and, for existing sensor capabilities, a consensus has emerged that simple dipole models are adequate for most applications. These models can now be used to predict confidently the sensor response to a target of interest to produce “sensor response curves” plotting signal strength versus depth. This is true for both munitions items and the proposed industry standard objects (ISOs).

We briefly summarize the methods for calculating responses to specific targets and important points in their interpretation. Specific details of the modeling and validation measurements are found in two reports published by the U.S. Naval Research Laboratory. (Ref. 3 and 4) In this report, we show example results for total field magnetometers and the EM61-MK2. Although not addressed here, the same methods may be applied to other EM sensors that operate in both the time and frequency domains. As new sensors are demonstrated successfully and become commercialized, similar curves will be generated. In principle, response curves can be calculated for any well-documented sensor.

The magnetometer curves are based on a point dipole model of a target. For the response of a cylindrical object like a UXO, at any given depth there will be a most favorable orientation, where the long axis is aligned with the earth’s field, and a least favorable, where it is perpendicular. Strictly speaking, the magnetometer response curve depends on the local geomagnetic field, which will vary somewhat from site to site, and the remanent magnetization (if any) of the target. While the earth’s field varies in magnitude by about 20% across the continental United States, it is not a concern on scales of hundreds of miles and will not vary within a site. Variations in the earth’s field can be handled by scaling the response curves. Finally, a key assumption in the model is that the object is in the so-called “far field” and can be modeled by dipole components alone. If an object is very near to the sensor, non-dipole effects will be evident in measured values.

The EM61 curves are based on a three-axis polarizability model. As with a magnetometer, the EM signal at any depth will depend on the relative orientation of the object and the sensor. For the EM61 directly over the target, the most favorable orientation is for an object with its long axis perpendicular to the transmit coil, and the least favorable is with it parallel. The EM response is strongly dependent on the sensor characteristics, including coil geometry, transmit moment, and the time gate when the secondary field measurement is made. The examples in this

report are for channel 2 of a standard configuration ½ m X 1 m EM61-MK2. The approach is equally valid for the other channels, which have been calculated similarly and are in Refs. 3 and 4. Again, the model assumes that the object is in the so-called “far field” and can be modeled by dipole components alone. If an object is very near to the sensor, non-dipole effects will be evident in measured values. The EM61 response curve is not affected by the earth’s magnetic field and will be the same for all sites, and an EM signal is not affected by remanent magnetization.

The curves can be used directly for magnetometer arrays, but when EM sensors are ganged in arrays and pulsed synchronously, the response curves will change. The quantitative assessment of arrays based on the EM61 sensor will require calculations to characterize a particular array arrangement. The simple Windows application on the accompanying CD can be used for these calculations, which are based on measurements of the target of interest at a few depths. However, it is also possible to use the single coil characterization curves and demonstrate empirically that the array arrangement meets or exceeds the performance as expected and is consistent with meeting project objectives.

### **2.1.1 Industry Standard Objects**

For nearly all munitions types, there are many configurations and no single, standard prototypical item exists. That is, a 60-mm mortar or 155-mm artillery round comes in many configurations that vary with usage and age. This variability makes it difficult to use real munitions as test objects for which quantitative, consistent signatures are needed. Even if that were not the case, actual inert munitions can be difficult to obtain in large quantities, such as would be needed for a combined test strip and seed program. In addition, if they are inadvertently left behind, inert munitions would alarm the public. Throughout the history of munitions responses, these latter two concerns have been addressed through the use of objects with similar size and shape that were thought to give responses similar to the munitions of interest on the site, termed simulants or surrogates. This resulted in a plethora of different objects, none of which had been particularly well characterized.

In place of this scatter shot approach, we propose the use of the three ISOs listed in Table 2-1. These items, shown in Figure 2-1, are schedule 40 pipe nipples, threaded on both ends, made from black welded steel, manufactured to an American Society for Testing and Materials (ASTM) specification. The part number here is from the McMaster-Carr catalog, but the items should be available at most plumbing or hardware stores at a cost of about \$2 for the small ISO, \$9 for the medium, and \$30 for the large. Items of this specification will produce consistent results regardless of where they are obtained. Response curves have been calculated to characterize these items, and corresponding verification measurements performed. (Ref. 3)

**Table 2-1. Industry standard objects characterized for use as munitions surrogates**

Item	Nominal Pipe Size	Outside Diameter	Length	Part Number <sup>1</sup>	ASTM Specification
Small ISO	1"	1.315" (33 mm)	4" (102 mm)	44615K466	A53/A773
Medium ISO	2"	2.375" (60 mm)	8" (204 mm)	44615K529	A53/A773
Large ISO	4"	4.500" (115 mm)	12" (306 mm)	44615K137	A53/A773

<sup>1</sup> Part number from the McMaster-Carr catalog.

An example of the response curve for the small ISO for an EM61-MK2 is shown in Figure 2-2, where the peak response is plotted versus depth to the center of the item. Depth is presented in two ways: the scale on the top axis is the depth of the object below the ground surface (bgs) if the cart is operated at the standard 40-cm coil height consistent with the manufacturer-supplied wheel arrangement, while the bottom axis reflects total distance from coil to object and can be used for any alternative deployment arrangement. The two dashed curves are the modeled sensor response for the item in its most and least favorable orientations, and the symbols show the verification measurements. As expected, all the measurements lie between the lines and only those of objects in the least favorable orientation approach the lower line.



**Figure 2-1. Industry Standard Objects**

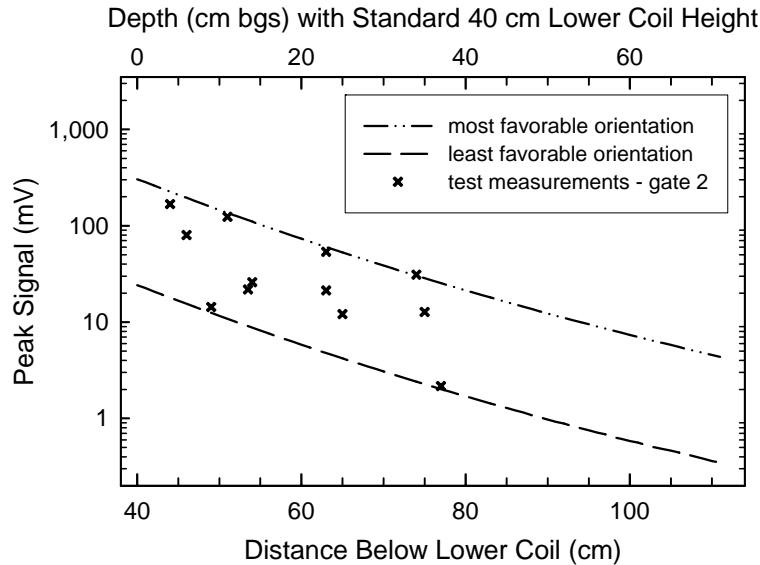

**Figure 2-2. EM61-MK2 response curve (time gate 2) for the small ISO. Dashed lines are the modeled curves for the most and least favorable orientations. Measurements are for objects in a variety of orientations and fall within the expected bounds of the upper and lower curves.**

For the purposes of a test strip, where the objective is to verify that a system is performing properly by reproducing the signal of a well-characterized target, any of these three items could in principle be used on any project, regardless of munitions type(s) of interest. Three items were chosen to support blind seeding. Here, one would select an ISO that meets the target selection criteria, so that the seeds would be expected to appear on the dig list. A detailed example of how this would be implemented is provided in Appendix A.

### 2.1.2 Munitions

Similar sensor response curves have been calculated and verification measurements made for select commonly encountered munitions. (Ref. 4) Figure 2-3(a) is an example for the EM61-MK2 response of a 4.2-inch mortar. The weakest response occurs when the mortar is horizontal, i.e., when its long axis is aligned parallel to the ground surface. The two dashed lines show the calculated response vs. depth for the object in its most favorable and least favorable orientations. The symbols show measurements of the peak signal at the second time gate of a standard EM61-MK2 as it was wheeled over the mortar. Depths are measured from the ground surface to the center of the mortar. Measurements were taken for various target orientations. Again, this is reflected in the spread of the measured response at any given depth. As expected, all measurements fall between the two curves, and only those measurements for which the mortar was in its least-favorable orientation approach the calculated minimum response curve; more favorable orientations result in higher measured amplitudes.

Figure 2-3(b) is the corresponding response curve for a total field magnetometer. It was prepared for the ESTCP Discrimination Study Pilot Program at former Camp Sibert in Alabama. (Ref. 5).

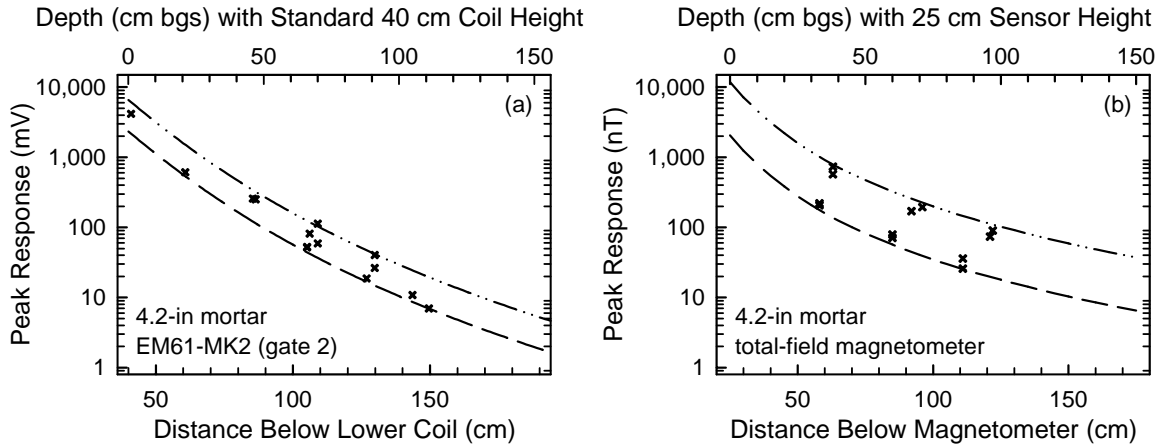

Figure 2-3. (a) EM61-MK2 response curve (time gate 2) and (b) total field magnetometer response curve for a 4.2-inch mortar

## 2.2 NOISE

Setting realistic expectations for detection performance at the site starts with sensor response curves for the targets of interest, like those in Figure 2-2 and 2-3. Whether or not a target will be detected obviously depends on the threshold signal level that is chosen for anomaly selection. Whether or not a target can be detected *reliably* also depends on whether or not the response it produces in the sensor is obscured by noise fluctuations in the sensor output. In this sense, the noise sets a limit on the response curve below which the target cannot be reliably detected.

The noise is the background of sensor output fluctuations that are not related to a target response. It can include contributions from the sensor electronics, sensor motion relative to the ground and the geomagnetic field, geologic structure in the ground, noise in the atmosphere from natural and man-made sources, and interference from small metallic debris near the ground surface and metal carried by the operator.

Figure 2-4 shows examples of target signals embedded in noise for a standard EM61-MK2 at the second time gate. The noise amplitude is 2 mV peak-to-peak or 0.35 mV root-mean-square (RMS). In Figure 2-4 (top), there is a 60-mm mortar at a depth of 26 cm at a distance of 20 m along the track. It is aligned with the long axis across the survey track, at horizontal orientation. The corresponding targets for Figure 2-4 (center) and Figure 2-4 (bottom) are a 37-mm projectile and a 20-mm projectile at the same location with the same depth and orientation. The signals were calculated using the procedures described in the response curve report. All the traces are plotted with the same vertical axis scale, and the insets show magnification for the 37-mm and the 20-mm.

Signals from the 60-mm mortar and the 37-mm projectile are clearly visible, while the signal due to the 20-mm projectile is lost in the noise. No signal is observed for the 20-mm round even in the inset magnification. The peak signal for the 20-mm projectile is 0.75 mV. Although this is about two times the standard deviation or RMS background (0.35 mV), the signal looks much like any of several nearby noise fluctuations. A larger signal would generally be required for reliable detection.

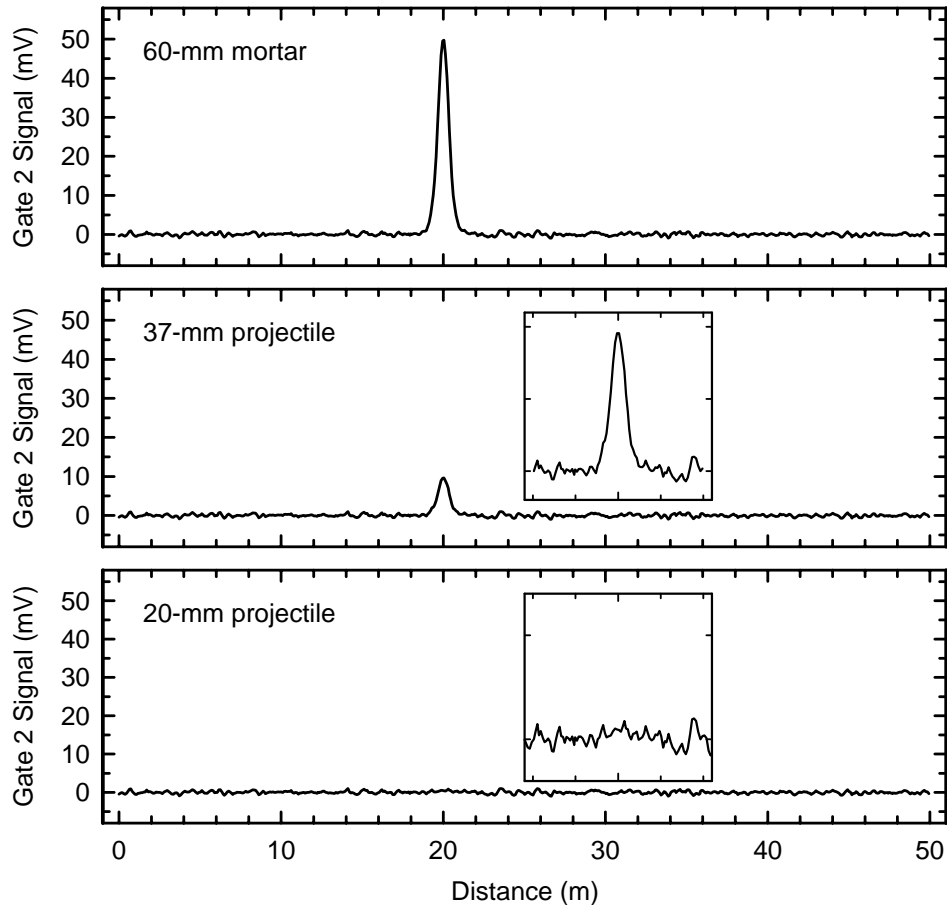

**Figure 2-4. Example signal plus noise traces: (top) 60-mm mortar, (center) 37-mm projectile, (lower) 20-mm projectile. All targets are buried at 26 cm depth oriented horizontal across the survey track direction. The peak-to-peak noise level is 2 mV, and the RMS noise level is 0.35 mV.**

The noise in this example is typical of well-collected data at a fairly benign site. It would easily allow for detection performance at the levels cited by The Interstate Technology and Regulatory Council. (Ref. 2) However, studies of motional and other operator-related noise have shown that bouncing the sensor over ruts, metal embedded in the wheels, cable movement, and metal carried by field personnel, in addition to more intense geological background or extensive small metallic clutter, can introduce significantly larger fluctuations in the sensor output. (Refs. 6 and 7) Severe noise has serious adverse consequences for detection performance and, if it is not recognized, can create unrealistic expectations of what is actually detected. Noise measurements in the IVS and ongoing monitoring of noise in the production data will identify such problems.

### **2.3 CONSIDERATIONS FOR INTERPRETING MEASUREMENTS**

Any measurement comes with uncertainties. In the case of quantitatively analyzing the geophysical data for consistency in the signal, we will consider two primary sources of uncertainty:

- errors in the depth to which test strip or seed targets are buried and
- offset between the center of the sensor and the center of the target.

Both can be quantified and the results used to set acceptable fluctuations in measured values. In addition, we briefly discuss relative orientation of sensor and target and remanent magnetization, and how each affects the ability to interpret measured values and set appropriate error bars.

### 2.3.1 Uncertainty in Burial Location

Burying targets to an exact depth and orientation can be difficult. It is easy to imagine numerous ways in which the exact location of a buried object can be off by up to a few centimeters. When the location of the target is measured, the crew must estimate the center of the target. When the item is covered, the motion of replacing the dirt can move the target. After the target has been buried, it may settle. Since the target's peak signal strength is strongly dependent on the distance between the target and the sensor, small errors in depth can translate to measurable differences in signal. In the case of the small ISO shown in Figure 2-2, the expected signal for the item buried at 20 cm in the least favorable orientation is 5.8 mV. If an error of  $\pm 5$  cm is allowed in the burial depth, the range of expected values is 4.2-8.1 mV. This is a nearly 50% variation in the measured signal. Similar variation will be seen of alterations in the sensor height caused by bumpy terrain.

### 2.3.2 Along-Track Offset

The response of an EM61 is fairly constant across much of the width of the coil. This is illustrated in Figure 2-5, which shows the peak amplitude measured for 37-mm projectile 50 cm below the coil (10-cm BGS for standard coil height) oriented horizontally along track, as the center of the coil passes over the target with increasing offset. At zero offset, the center of the coil passes directly over the center of the object and at  $\pm 50$  cm the object is beneath the edges of the coil. The peak signal is about 13.2 mV when the object is beneath the center of the coil, and for offsets of  $\pm 25$  cm, it falls off to 11.5 mV. For data collected with 0.5-m line spacing, any object will fall within  $\pm 25$  cm lines, and the measured fall-off guides the variability that must be allowed in quantitatively interpreting whether measured signal values are consistent with a properly functioning instrument. The curve will be different for other depths and orientations.

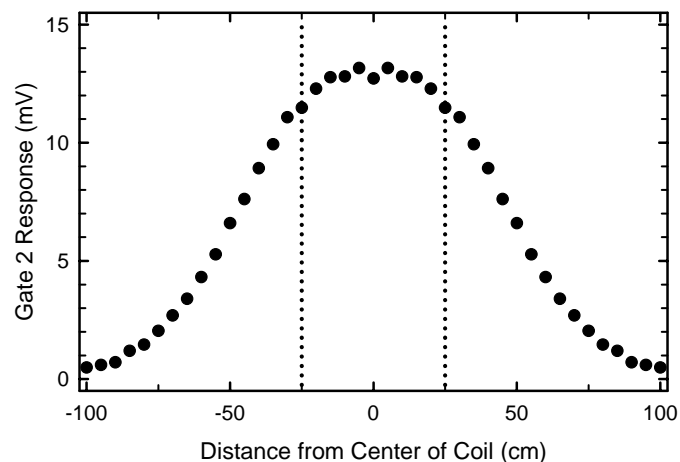
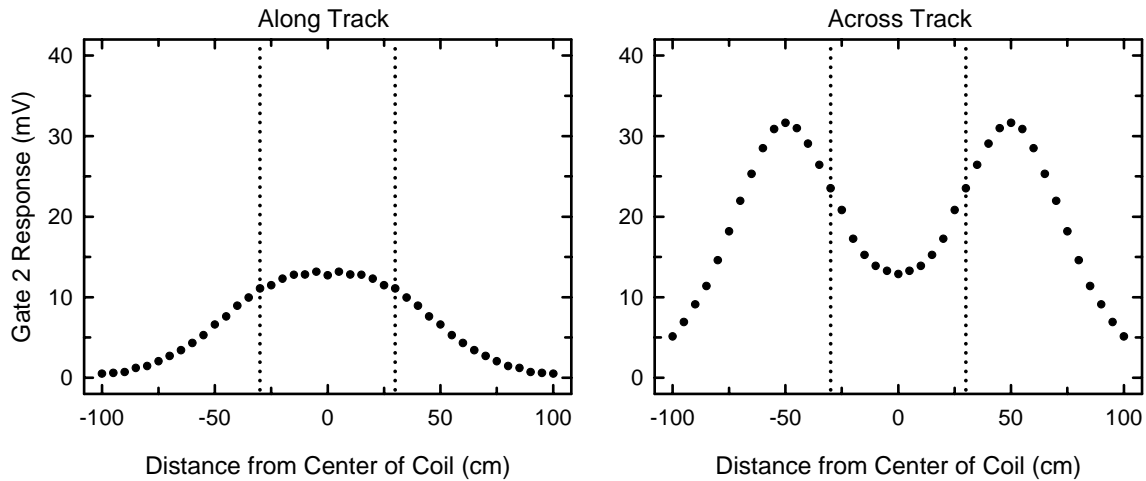

Figure 2-5. Anomaly amplitude as a function of cross-track position for a 37-mm projectile horizontal, along-track 50 cm below the coil of an EM61-MK2. The coil is 1 m wide. The vertical dotted lines at  $\pm 25$  cm represent the maximum offset of an object passing under the coil at 0.5-m line spacing.

### 2.3.3 Target Orientation

The effect of relative orientation between the EM61 and the object is taken into account in the sensor response curves. For interpretation of the measured data, it is important to understand, at least conceptually, how these variations come about. The measured signals for an item in two orientations under an EK61-MK2 as a function of cross-track position are shown in Figure 2-6. These results can be understood when one considers the direction and magnitude of the primary field generated by an EM61, which is presented as a vector plot in Figure 2-7.



**Figure 2-6. Anomaly amplitude as a function of cross-track position for an item in two orientations under an EM61-MK2. The vertical dashed lines represent the largest offset expected for a survey line spacing of 0.6 m.**

When an item is centered under the EM61 coils, the primary field is entirely in the z-direction (vertical down) so a horizontal cylinder is excited only on its short axis, as shown by the center object in Figure 2-7. In both the cross-track and along-track orientations, the signal amplitude at zero offset is the same. As the item is moved left or right of the sensor centerline, the field decreases in total magnitude, but the horizontal component grows larger. For the case of an item oriented along track, the object on the left in Figure 2-7, this results in the anomaly growing smaller as the items is moved off center: the item is still excited only on its short axis and the overall magnitude of the primary field is decreasing. By contrast, if the item is oriented across track, as illustrated by the object on the right in Figure 2-7, the horizontal component of the field excites the long axis, which has a higher response. This more than makes up for the decreased total magnitude and results in a larger signal in the positions offset from zero. For cylindrical items oriented with their long axis along track, the double hump will appear in the down track direction

Of course, the relative orientation and offset of the object and sensor for survey measurements will be random and unknown. The potential effects of a survey design on measured amplitudes, as well as consistency among measurements, must be taken into account in setting appropriate tolerances for the deviation between modeled values and measurements.



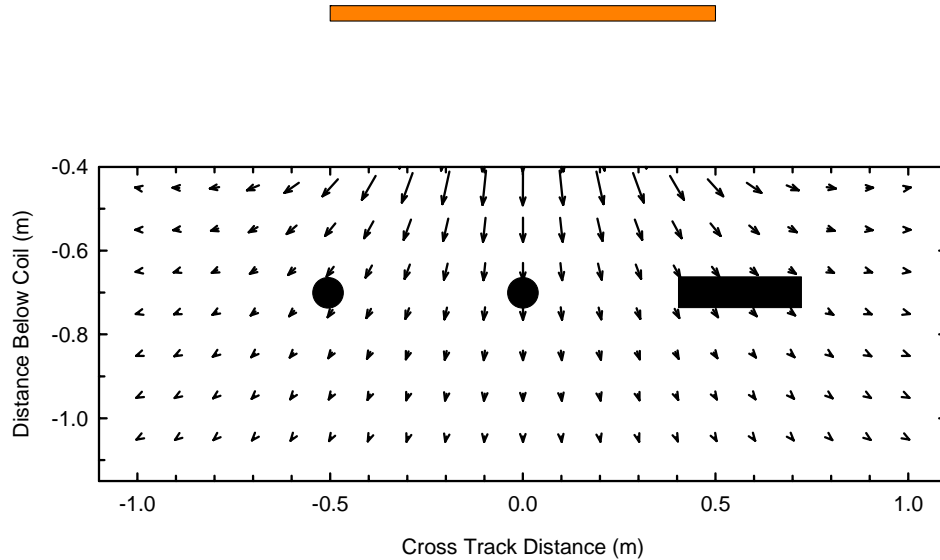

Figure 2-7. Magnitude and direction of the primary field generated by an EM61-MK2 (indicated by the orange coil) as a function of depth and cross-track distance. The three objects represented are oriented horizontally, with the left in the along track direction offset from the coil center, the middle in the along track direction under the center of the coil and the right in the cross track direction offset from the center.

### 2.3.4 Remanent Magnetization

Manufactured items often have permanent magnetization, referred to as remanence, that is a result of the manufacturing process. It is likely that ISOs will have some amount of remanent magnetization. If the remanent magnetization is significant, it will be an important consideration, as the magnetometer curves include only the induced contribution to the magnetic signature, that part that is a result of a permeable object locally altering the earth's field. The measured field will be greater than or less than the induced part by the amount of remanence, depending on the relative orientation of the permanent and induced moments. If an item has a significant amount of remanence, the curves cannot be used predict quantitative responses.

It is a simple matter to check whether an item has remanence. The item is lined up with its long axis parallel to the earth's field, and the magnetic signature is measured. The item is then rotated by 180° and the measurement repeated. If the readings are the same, the item is not magnetized and the induced moments can be used. If they differ, the item has remanence, and the project team will need to decide how to proceed. Items with remanent magnetization can be demagnetized to preserve the quantitative aspects of the GSV. Procedures for demagnetization vary in complexity and in the quality of the end result.

### 2.3.5 Error Bars

Setting quantitative requirements for the allowable deviation of measured sensor response from the sensor response curves, as well as for daily consistency, will require allowing for the errors from all sources. The error associated with inaccuracies in the burial depth of an emplaced target is shown in Figure 2-8. The horizontal error bar represents +/-5 cm in the depth of the target. The vertical error bar captures twice the measured noise. In this case, the error bar is dominated by the contribution from the error in burial depth.

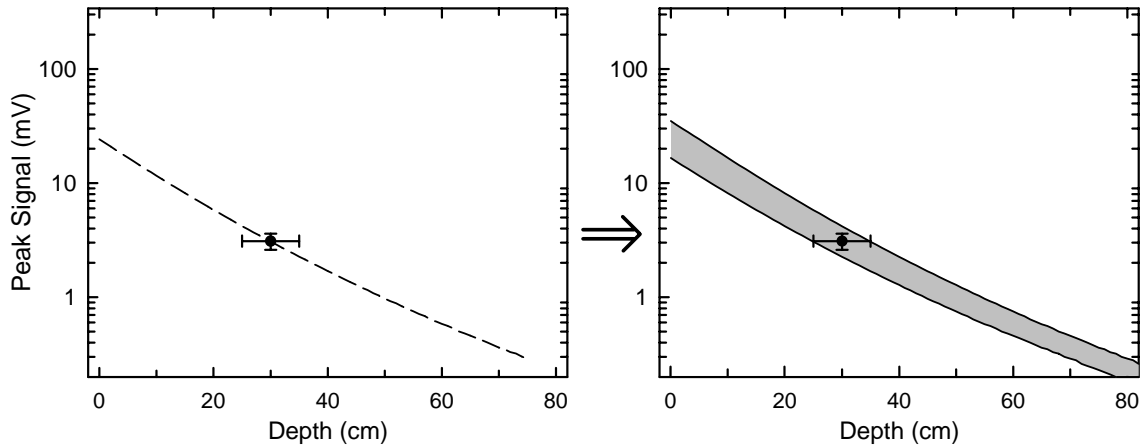

**Figure 2-8. Variability in the expected sensor response caused by error in the target burial depth**

Accounting for the errors from any source can be thought of as transforming the sharp line that represents the expected sensor response into a band. The sharp lines are simply a series of individual points, assuming a perfect measurement. The band can be thought of as a continuous series of lines that encompasses the magnitude of the uncertainties. This is illustrated in Figure 2-8.

Quantitatively accounting for the appropriate variability from all noise sources will be a substantial undertaking. It may be preferable for project teams to consider the main sources of noise, as we have done here, and then set an empirical safety factor that comfortably encompasses the expected variability.

## **2.4 APPLYING RESPONSE CURVES TO ANOMALY SELECTION CRITERIA**

In a typical munitions response survey, the sensor is used to survey the field in a raster pattern. After data collection, the raw data are leveled, background corrected, and mapped. Then, either line-by-line or from a data image, regions of anomalous response are selected and marked as potential targets to be dug up.

One approach to target selection, which has been used on many sites, is to select all points with sensor readings above some multiple of the survey noise as anomalies. This approach is not tied to the targets of interest, which have signatures that are site-invariant. On sites where the noise is low, it can result in placing many low-amplitude anomalies on the dig list that cannot possibly be targets of interest. Worse, on sites where the noise level is high, it can result in a threshold that is too high to capture all targets of interest. These tradeoffs are seldom acknowledged nor factored explicitly into the decision making process, creating expectations that cannot be met.

The response curves can be used to construct an alternative approach to develop or justify anomaly selection criteria, which is tied to the targets of interest. Given that the minimum signal amplitude from each of the targets of interest can be predicted and verified with measurements, one would model the signal expected for each of the targets of interest and set the threshold at the smallest sensor reading expected from the most stressing target of interest at its maximum depth of interest. Statistical fluctuations in measured signals can either be explicitly accounted for or a safety factor can be applied. The implication of this approach is that anomalies due to

potential metal objects that are too low in amplitude to possibly be targets of interest at their depth of interest are left off the dig list.

This approach to anomaly selection was used at the recent ESTCP Discrimination Study at former Camp Sibert, Alabama, with no targets of interest missed. (Ref. 5) Of course, the detectability of an object depends on both the minimum signal expected from the object at depth and the site survey noise. For the Camp Sibert example, the expected signal from the target of interest, a 4.2-in. mortar at the maximum depth of interest was well above the RMS noise. When the signal level far exceeds the noise, all targets should be detected, barring some failure in the data collection or analysis process. As the noise increases or the expected minimum signal decreases, the fraction of targets detected will decline until the object becomes undetectable with the sensor that is being used.

The response curves may also be used to quantify the results that can be expected for anomaly selection criteria that are set in anyway. For example, if it is desired to remove all “detectable items,” the response curves can tell you the maximum depth to which an object can be detected for measured site noise conditions. If the emerging idea of combining anomaly footprint with maximum amplitude is used, the response curve and noise measurements remain relevant to evaluating the amplitude of signals that may be detected above the site noise.



### **3.0 INSTRUMENT VERIFICATION STRIP**

The purpose of the instrument verification strip (IVS) is to provide information that will verify on a daily basis that the geophysical sensor system can deliver the expected detection performance. As such, it is intended to:

- verify that the equipment is working properly and
- measure site noise from which the target signal must be extracted.

The IVS envisioned consists of a line of well-characterized objects, preferably ISOs, buried in an area representative of the local site conditions. Data would be collected prior to beginning production work using the same protocols specified for the field data collection. Then, the IVS would be visited twice daily, at the start and finish of the field work, to verify proper sensor operation. Noise will be measured in a convenient adjacent area. It is envisioned that the IVS could be constructed, data collected and analyzed, and the results reviewed for approval to proceed in a single day.

#### **3.1 SPECIFYING THE IVS**

A convenient area that is representative of the production site should be chosen for the IVS. It should be free of discrete anomalies that would meet the anomaly selection criteria but should contain representative local geology and perhaps small metallic clutter if that is expected on the production site. In some circumstances, multiple IVS locations may be preferred. If the site is very large, additional locations would save undue travel time for daily checks.

##### **3.1.1 IVS Items and Placement**

The contents of the IVS can in principle consist of any well-characterized objects. Our preference is to use the ISOs, for which sensor response curves have been produced. Strictly speaking, only one item would be sufficient to provide the data required for physics-based confirmation of performance, that is, to ensure that the sensor system is recording the expected signal at the correct location. Multiple items may be desired to provide a range of signals. To that, a project team could add inert versions of the targets of interest. The IVS outlined here is centered around a modest number of the ISOs.

The objective of the IVS is to verify correct operation of the sensor, not to test its maximum performance, which we can calculate. Thus, items buried in the IVS should be at depths that provide signals well above the sensor noise level so that measurements of sensor signal level will not be contaminated by significant noise. However, because of the way expected signals are calculated, the targets should be sufficiently far from the sensor that the dipole approximation is valid. Both the conditions of sufficient signal and dipole response can be met for burial depths of three to seven times the target's diameter. For example, a 1-inch ISO buried at seven times its diameter in the least favorable orientation provides a 4.8 mV signal for a channel 2 of an EM61-MK2, which would provide sufficient signal for accurate quantitative measurements in the background of 0.3 mV RMS (or 2 mV peak-to-peak) noise shown in Figure 2-4.

The items will be buried in a straight row and are not intended to be blind to the sensor operator. To the contrary, the lane to be surveyed should be well marked, so that the sensor will pass directly over the targets, providing an accurate measure of the peak signal. The distance between

the items should be sufficient so that the sensor signal level returns to the noise level between the IVS items. This might require a significant distance between items (perhaps up to 12 m for the large ISO if the sensor is a Cs vapor magnetometer). Depending on the configuration of the area available, items may be buried in multiple adjacent shorter rows, which should be sufficiently far apart that the signals do not overlap.

### 3.1.2 Noise Measurements

Noise measurements will be made on an adjacent strip containing no discrete anomalies or non-representative terrain or geology that will affect the instrument. As noted in Section 2, a number of phenomena contribute to total sensor system noise. However, the purpose of the test strip is not to define the individual contributors to the noise but instead to quantify overall noise for the particular location, which will govern which target signals will be detected reliably in the conditions on the site. Noise measurements will also verify that the noise level is consistent day-to-day.

To be most convenient, the background noise measurements should be made adjacent to or within the IVS. However, noise measurements should be made far enough from the buried targets so that their signals do not contaminate the measured noise background. The offset distance will depend on the targets buried in the IVS and on the sensor characteristics. For example, if the sensor is a cesium vapor magnetometer, the offset distance will generally have to be larger than for an EM sensor because of the  $1/\text{distance}^3$  signal falloff for the magnetometer, compared to the  $1/\text{distance}^6$  for the EM sensor. Similarly, the use of larger test items (e.g., a 155-mm projectile vs. a 60-mm mortar round) will require larger offsets. Table 3-1 provides example nominal minimum offset distances between the IVS targets and location of the noise measurements, assuming a desire to have the target signal below 0.5 nT for the magnetometer and 0.25 mV in gate 2 of the EM61.

**Table 3-1. Example lateral offsets between the target IVS and noise strip for a magnetometer and EM61-MK2**

	<b>EM61-MK2</b>	<b>Cs vapor Magnetometer</b>
ISO - S	> 1.5 m	> 2.5 m
ISO - M	> 2 m	> 4 m
ISO - L	> 2.5 m	> 6 m
60-mm mortar	>2 m	>4 m
105-mm projectile	>2.5 m	>6 m

Measured noise will depend on how the sensor is operated, so noise data must be collected following the same procedures as those that will be used to collect and process production survey data.

### 3.2 DATA COLLECTION

The IVS is meant to be a dynamic test. Data should be collected and processed in the same way that production field data collection will be done. For the IVS data to be representative, adjustable parameters such as height above ground and survey speed must be replicated, but just

as importantly, the data processing steps should also be the same. The IVS is not intended to replace any static tests that would be done routinely as part of the operator's normal quality control (QC) procedures.

The data collected prior to initiation of field work will be somewhat more extensive than what would be collected daily. A data collection protocol similar to that illustrated in Figure 3-1 is envisioned.

- At a minimum, one line of data would be collected with the sensor passing directly over top of the items. This will provide the peak signal measurements to confirm sensor operation.
- A line of data will be collected offset from the IVS to measure site noise.

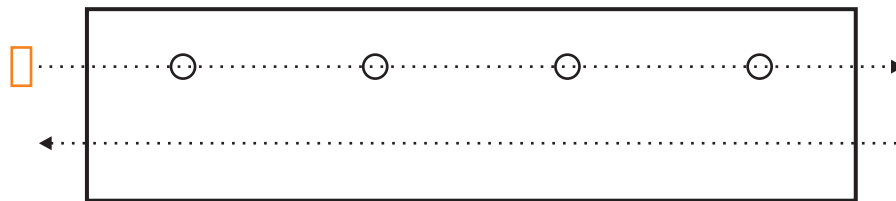

**Figure 3-1. Required data collection on the IVS**

To provide confirmation of additional project objectives, additional data could be collected, as illustrated in Figure 3-2. For example,

- Two additional lines of data could be collected, the first offset from the center by half the planned line spacing and the second by the full line spacing in the same direction. This will provide confirmation that the line spacing is sufficiently close to detect the targets of interest.
- A line of data could be collected offset from the center by the planned line spacing in the other direction. The three lines of data collected as prescribed for field data collection can be used to produce a two-dimensional map to confirm geolocation accuracy in both directions and check for latencies in the data.

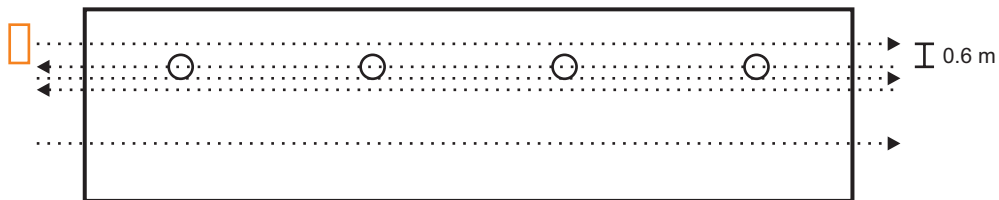

**Figure 3-2. Optional additional data collection on the IVS**

For daily instrument checks, data would be collected in one direction down the center of the target strip and in one pass over the noise strip. The main objective of the daily run is to check that peak signal levels remain consistently as predicted and that the system noise levels have not changed, which would indicate an equipment malfunction. The single pass will measure geolocation accuracy only in one direction, which will still be sufficient to identify a failure.

Noise would also be monitored through the production data to identify any inconsistencies with the noise strip measurements that would change the expectations for detection performance.

A sample protocol for both initial and daily checks is outlined in Appendix A.

### 3.3 DATA ANALYSIS AND INTERPRETATION

The three primary data products from the IVS should illustrate consistency of signal strength, magnitude of noise, and geolocation accuracy.

For each item in the IVS, the peak signal strength from the initial day's data should be compared to the expected signal for consistency, as illustrated in Figure 3-3. In all cases, the signal should be no lower than the predicted signal for the least favorable orientation, and only the signals for objects in that orientation should approach the lower line. As discussed in Section 2, appropriate allowances should be made for error sources.

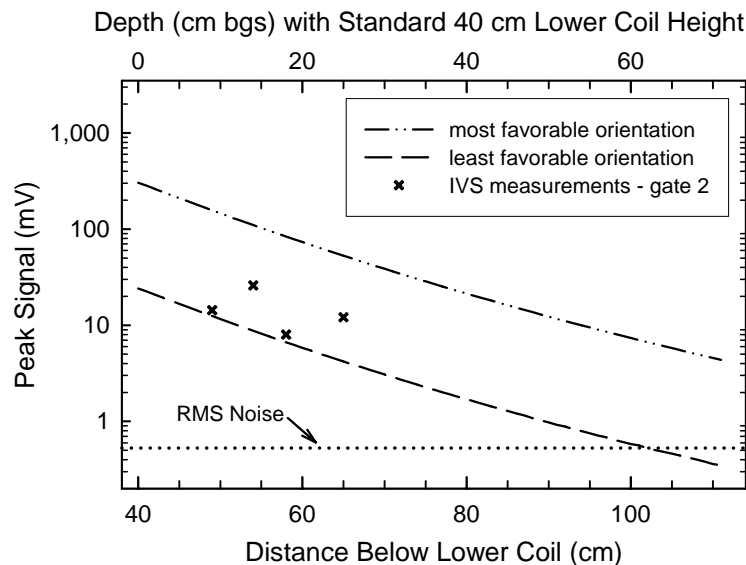
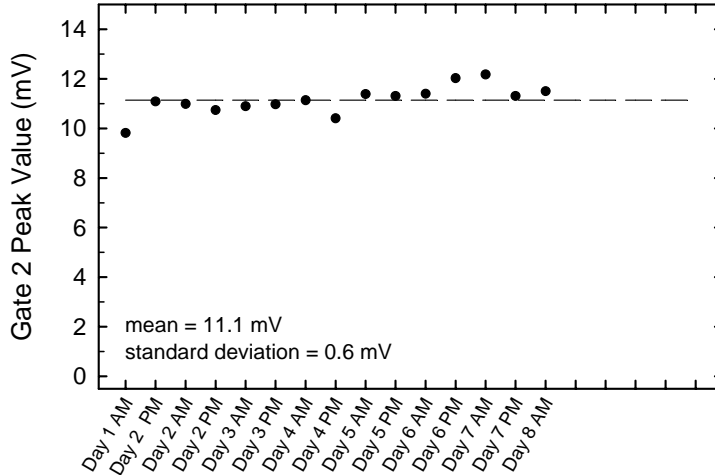

Figure 3-3. EM61-MK2 response curve (time gate 2) for the small ISO

Daily runs of the IVS should be evaluated for consistency. Even with very high signal-to-noise ratios, there will be some run-to-run variation in the measured peak return from targets in the IVS. Not only will sensor total noise provide some variation, but also minor errors in navigation and sensor platform "bounce" will cause signals to vary. Figure 3-4 provides an example plot of measurements from a small ISO buried at a depth of 11 cm in its least favorable orientation. The mean signal is 11.1 mV compared to the expected 10.8 mV. The standard deviation is 0.6 mV (~5%), which is comparable to the RMS site noise, which was measured at ~0.5 mV. The variation is also consistent with the signal fluctuation expected for the sensor bouncing  $\pm < 1$  cm.

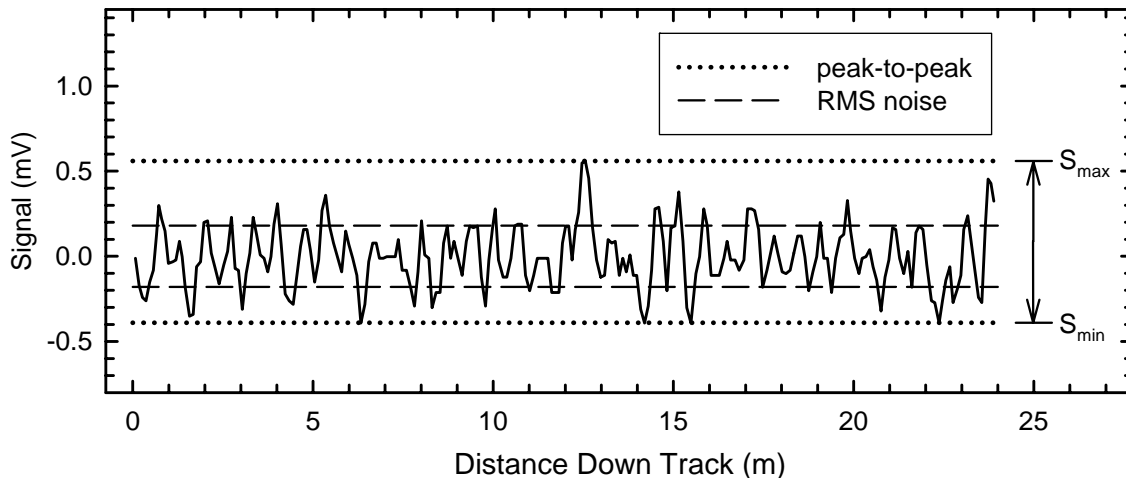



**Figure 3-4. Daily signals recorded for a small ISO at a depth of 11 cm in its least favorable orientation**

Other factors will also affect the peak signal measured by the sensor. For an EM61, while bounce is an issue, lateral offset is much less of an issue. The cart configuration typically has a 1-m cross-track coil configuration, and variations in target location within the coil footprint will produce minimal changes in the peak signal.

Interpretation of the noise measurements should be straightforward. Figure 3-5 shows an example noise trace from data collected on a 25-m path. From this, one may extract either the peak-to-peak or RMS noise. As illustrated in Figure 3-5, the RMS noise should be compared to the expected signals from the targets of interest to verify that they can be detected reliably. Targets with peak signals that exceed the RMS noise by a factor of about three to five or more should be detected.



**Figure 3-5. Noise trace for gate 2 of an EM61. The RMS noise is 0.36 mV and the peak-to-peak is 1.0 mV.**



## **4.0 BLIND SEEDING IN THE PRODUCTION SITE**

Blind seeding in the production site is an integral part of this concept. Seeds provide an opportunity for ongoing monitoring to build confidence that all the steps leading to the product from which targets are selected are working. The failure to detect a seed target will allow a project team to recognize that problems exist and provide a means to identify root causes and undertake corrective action while still in the field.

The seeding program envisioned calls for the placement of known objects at surveyed locations that are blind to the survey and data processing teams at sufficient frequency that they are useful for daily quality checks. At a minimum, the seed items should include one or more of the three industry standard objects (ISOs) discussed in Section 2. The main purpose of the seeds is to provide ongoing verification that known objects produce signals that are expected. As such, they need not mimic the munitions of interest in every detail. The ISO that is selected should have a signature that would meet the anomaly selection criteria; that is, you should expect that the seeds would be selected and placed on the dig list. Although not required by the GSV, the project team may also want to include inert versions of the munitions expected at the site in order to support public acceptance.

The role of seeds is more than just redistributing the GPO; seeds would be integral to the larger QC process, as discussed in Section 5. Since the objective is to use the seeds as a QC tool, they should be planted such that they are within the expected detectable range of the sensors, so that the failure to detect any seed will be a meaningful indication that there is a quality failure. Since it would be hard to interpret missing an item if it is not expected to be detected 100% of the time, the seeds should be placed such that they ought to all be detected. They are not intended to produce a statistically meaningful probability of detection at the end of the project.

The seeding program outlined in this section is aimed at 100% production survey work to support the removal of munitions. Parts may be adapted to other applications such as transect-based investigation.

### **4.1 SPECIFYING THE SEED PLAN**

Details of this approach, including seed selection, density, depths, and the like, are site-specific decisions. Performance requirements will have been established during the data quality objective phase of project development and are used to guide the design parameters selected for the production seeding. The specific objectives will depend on types of munitions expected and cleanup standard for the anticipated use, among other things. Other considerations such as ensuring contract compliance may drive modifications to the seed plan.

#### **4.1.1 Selecting the Seed Targets**

The seed program should be built around the ISO that is appropriate to the munitions of interest on the site. In most cases, the ISO should meet the anomaly selection criteria and have a signature with a magnitude and spatial extent that is close to the object of interest. On most sites, there will be more than one munition type of interest. In this case, the ISO should be selected based on the most stressing target. For example, the site team might pick the object of interest with the smallest spatial signature, as this object is likely to drive the DQO on lane spacing.

ISOs may be supplemented with inert munitions. Although this is not required for the main objective of the seeding, that is to prove that the detection system is working and that the targets of interest will be detected as expected from prior tests, the use of some inert munitions may be necessary to satisfy the public or aid in communication. As with the ISO, the munitions-like objects used for seeding should be selected with a specific objective in mind. It may not always be best to seed the smallest item of interest. For example, a hand grenade generally will be found in the top 6 inches. A larger deep item may have a lower amplitude signal, but the smaller shallow items may still drive the DQOs for line spacing. These factors, along with others identified by the project team, should be carefully weighed in selecting any additional seeds.

Other common field procedures may be exploited to augment a blind seed program. Corner stakes at known locations can be used to verify location accuracy, latency, consistency of response, and other data quality measures. Because they are at locations known to the survey and data processing teams and they appear in a regular pattern, they would not be regarded as acceptable blind seeds.

#### **4.1.2 Quantity, Depth and Orientation**

On average, at least one seed should be encountered per day per crew. For a field crew using a cart-based EM-61, the daily production rate might be 1 acre. One seed per acre would be appropriate. For a towed array system, the production rate may be 5-10 acres per day. It may be advantageous to place a higher density of seeds in the lots to be surveyed in the first few days of production.

Seeds should be buried at depths where they are expected to be detected. It would be difficult to interpret a failure if items were buried at their most stressing depths, such that their expected probability of detection was not 100%. Seeds may be buried in any variety of orientations. Quantitative evaluation will be most straightforward for seeds buried in the horizontal (least favorable) orientation, for which the sensor response curves are calculated. For simplicity of interpretation, it may be useful to bury all seeds at the same depth and orientation to check for consistency in the measured target responses throughout the life of the project.

#### **4.1.3 Emplacement**

Seeds will be buried in the production site, where UXO is expected to be present. The seed plan will specify planned locations or frequency with which the seeds will be encountered. The planned locations for seeds must be flexible so that they may be emplaced safely. Anomaly avoidance should be practiced in the burying of seeds, and all procedures should be in compliance with relevant safety guidelines. As long as the actual buried location is accurately recorded, nothing is lost by moving a planned seed by a few meters.

Seed locations should be surveyed to an accuracy that equals or exceeds the expected accuracy of the positioning system. Locations should be based on a certified monument that will be used for the surveying. Depth to a specified point should be recorded. All the depths in this report and in Refs. 3 and 4 are to the center of the object. For nonspherical objects, such as pipes or inert munitions, the orientation of the object in the ground should be recorded. For the primary purpose of verifying signal levels and target selection, most seeds should be buried one to a hole. However, if a stressful test of anomaly resolution is desired, a fraction of the seeds could be

buried with more than one object stacked or offset in the same hole. This would allow a test for whether a hole is properly cleared.

#### **4.1.4 Custody of information**

Evaluation of the blind seeds could in principle be done by the QC arm of the performer, customer, or an independent third party. What is important is to maintain the integrity of the *blind* seeds. This requires that the truth information be segregated from the people collecting and processing the data, as well as those performing the target picking. If a blind seeding program is to be conducted by the performer, appropriate fire walls are needed between the planning and evaluation of seeds and the data collection and analysis sides.

### **4.2 WHAT DATA ARE TAKEN AND HOW ARE THEY EVALUATED?**

Performance on the seeds should be evaluated at sufficiently short intervals that quality control failures can be identified and corrected with a minimum of lost data. At the beginning of the project, this evaluation should be done daily. This will require a daily turnaround of the data analysis so that seed item detections and responses can be assessed in a timely manner.

The data required from the data analyst include information commonly found in target lists. For each anomaly that meets the target selection criteria, the analyst should report at a minimum the peak signal strength and other required parameters and the X,Y location.

The evaluation team will:

- Determine whether seeds are included on that target list.
- If yes, determine if signal strength and other required anomaly parameters are appropriate and the location accuracy within specification.
- If not, determine if there is a signal that should have been picked. The strength and coordinates of this signal should be evaluated to determine why it was not selected. A root cause analysis should be initiated.
- If no appropriate candidate target can be identified in the data, then a root cause analysis should be initiated.

### **4.3 WHAT IS THE PRODUCT?**

1. *Signal strength.* Figure 4-1 shows a plot of the signal strength of seed targets. This plot would be updated as the seeds are encountered. The expected values for this example target at its most and least favorable orientations are shown in the dashed lines, and the individual measurements are represented by the dots. The seeds in this example are buried at a variety of depths and orientations.

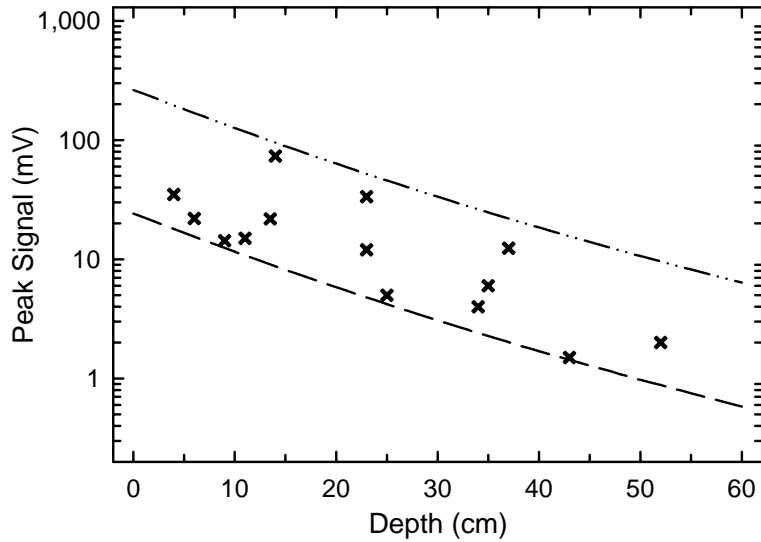

Figure 4-1. Signal strength of seed targets compared to sensor response curve

2. *Location accuracy.* Figure 4-2 shows a polar plot of the location accuracy for seeds. The plot depicts the offset of each seed location if the target were centered at (0,0). This also would be updated daily as the seeds are encountered.

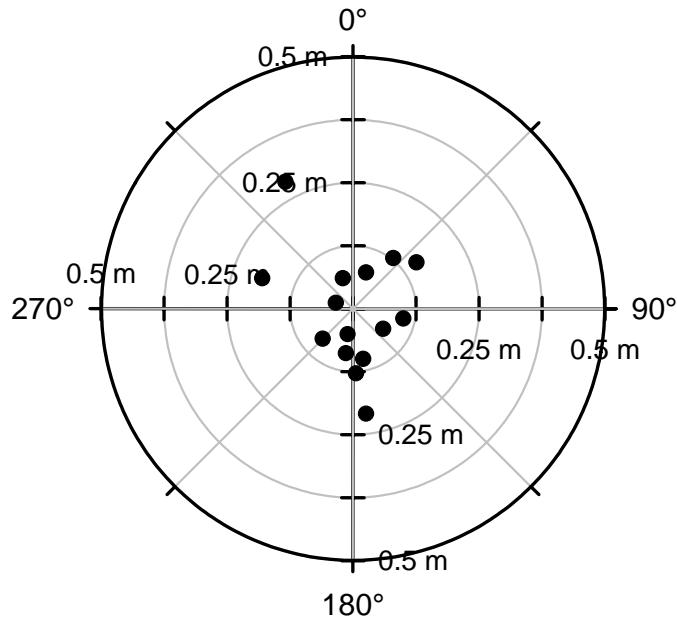
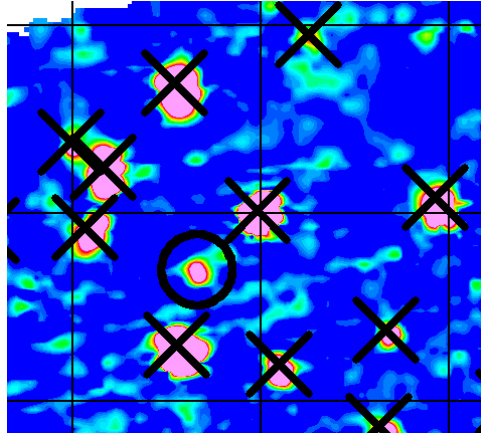

Figure 4-2. Location accuracy of seed targets

3. *Detailed failure analysis.* Figure 4-3 shows an example of geophysical data that would be examined in the event of a failure to detect a seed. The X's represent targets that appear on the pick list, and the circle is the location of a seed that was not detected. In this case, a response is present at the location, but it was not picked in the analysis process. A root cause analysis would be initiated to identify the failure and, if necessary, prescribe a corrective action.



**Figure 4-3. Failure analysis of seed that was not selected as a target. The X's represent picked targets. The circle represents a seed location where no target appeared on the dig list.**

4. *Anomaly resolution.* Seeds are expected to appear on the dig list and to be dug, blind to the recovery team, like any other target. The dig teams should report the target location and item description. The analyst should review the dig information and verify that the recovered target is consistent with the anomaly characteristics. In the event that more than one seed item is buried at a single location, the recovery team should report that multiple items were recovered and indicate that the hole was cleared following the established procedures.





## 5.0 DISCUSSION

Historically, a wide variety of objectives have been cited for GPOs, some of which continue to be relevant while others have either been obviated by advances in the understanding of common sensors or were never addressed as intended by the GPO. It is essential that objectives that remain relevant be addressed within the GSV framework. Most objectives can be met with a combination of blind seeding and an IVS, but some may require additional quality monitoring of field data.

Particularly, we envision a comprehensive check of the first production lot (half day to a day) of data following successful completion of the IVS to support authorization to proceed to field work. The outcome of this check will validate that the data collection is meeting the DQOs and that the DQOs are appropriate to make the project objectives. In this section we discuss how the essential objectives can be met, as well as details a number of added benefits of GSV.

### 5.1 MEETING THE HISTORICAL OBJECTIVES OF GPOS

A list of key objectives that GPOs have attempted to address, extracted from documents produced by the Interstate Technology Regulatory Council (ITRC) and the U.S. Army Corps of Engineers (COE) (Refs. 8 and 9) is given in Table 5-1. Similar objectives from the two sources have been paraphrased and grouped. There are undoubtedly many more objectives cited in individual project documents over the years. While it is important that key objectives be addressed somewhere in the GSV framework, it is equally important to recognize that some of these objectives were never really addressed by a GPO and others are no longer relevant for most projects.

Here we briefly discuss each of these objectives and how they will be addressed by the GSV or make a case for those that will generally not be relevant or are unsuited to either the GSV or the GPO. In some cases, enhanced quality monitoring is suggested to supplement the data from the IVS and the blind seeds. It is not our intention to provide a comprehensive discussion of project quality, which is addressed elsewhere (Refs. 9 and 10), but only to highlight the recommended enhancements and their purpose.

*Select geophysical equipment.* GPOs typically are no longer used for the selection of equipment. In practice, the choices are limited to magnetometers and EM sensors for nearly all projects. The operation and responses of both are well understood. In fact, it is common to have selected the geophysical system before the GPO is ever constructed.

*Confirm that instrument selection is appropriate.* Instrument verification strip and noise measurements will either confirm that the selected instrument can detect the targets of interest or inform the site team that it cannot, so appropriate modifications to the sensor selection or the expectations can be made. The IVS data will confirm that the sensor is operating as designed and that past measurement and model data will correctly predict the signal strengths from the objects of interest. Noise data acquired at the IVS will indicate whether targets of interest will be detectable at the required depths in the noise environment on the site. Continuous noise monitoring throughout the production data will indicate whether the conclusions from the IVS measurements will apply throughout the site. At some sites, the currently available instruments will be unable to detect all targets to all desired depths, and the data acquired through this approach will allow that to be recognized and support decisions about how to proceed.

*Train operators.* Sensor operators should arrive on site properly trained. Qualification of each operator/system combination to begin field work would rely first on successful completion of the initial run of the IVS, which will verify that the sensor system is working properly. The first production unit of data, perhaps from the first half-day to a day, would be subject to a comprehensive quality check, for items such as maintaining line spacing and down track speed to verify that the data are collected to specification. Blind seeds in the initial data collection would provide confirmation that the data collection, analysis and target selection procedures are meeting objectives.

**Table 5-1. Typical objectives of GPOs**

Objective	PS <sup>1</sup>	IVS	Seeds	Other	Comments
Select Geophysical Equipment	<input checked="" type="checkbox"/>				Presumptively selected based on site conditions and targets
Confirm Instrument Selection		<input checked="" type="checkbox"/>		<input checked="" type="checkbox"/>	Also by DQO monitoring through project
Train Operators			<input checked="" type="checkbox"/>	<input checked="" type="checkbox"/>	Contractor responsibility—however, DQO monitoring through project ensures that this is acceptable
Optimize Configuration and Data Collection Procedures	<input checked="" type="checkbox"/>				Presumptively selected based on predicted and confirmed target responses
Document Capabilities and Limitations/ Site-Specific Pd/Depth of Detection		<input checked="" type="checkbox"/>			Signal and noise document site-specific performance in GSV. Statistical parameters could never be supported by typical GPOs
Measure Noise		<input checked="" type="checkbox"/>			Also by DQO monitoring through project
Verify Signal Levels		<input checked="" type="checkbox"/>	<input checked="" type="checkbox"/>		
Approval to Proceed		<input checked="" type="checkbox"/>		<input checked="" type="checkbox"/>	Same as GPO but approval can often be reached quicker
Confirm Anomaly Selection Criteria		<input checked="" type="checkbox"/>	<input checked="" type="checkbox"/>		
Evaluate Contractor Data Analysis		<input checked="" type="checkbox"/>	<input checked="" type="checkbox"/>	<input checked="" type="checkbox"/>	Also by DQO monitoring through project
Demonstrate Anomaly Resolution			<input checked="" type="checkbox"/>		

<sup>1</sup> Presumptively Selected

*Optimize configuration and data collection procedures.* Data collection procedures can be set based on predicted and confirmed target responses. Vast experience over many years with the EM61 and magnetometers has added an empirical understanding of common configurations and procedures used similarly on many sites. This experience, when supplemented with the sensor response curve and signal fall-off measurements to quantify expected performance, can be used to set the most common variable parameters, such as line spacing. The initial day's

measurements on the instrument verification strip are specifically designed to provide confirmation that data collected as specified will detect the targets of interest as expected.

*Document capabilities and limitations/site-specific Pd/depth of detection.* These objectives are discussed together because they are all aimed at determining some variant of site-specific performance. The two most commonly cited capabilities and limitations are site-specific Pd and maximum depth of detection. These statistical measures could never be supported by GPOs containing only a few tens of targets. Signal strength as a function of depth can be calculated and has been for both the ISOs and many common munitions. By confirming that the sensor system is operating such that the expected signals are measured, the IVS verifies that the response curves may be relied upon. When combined with the site-specific noise, the response curves provide a quantitative and defensible indication of site-specific capabilities and limitations.

*Measure noise.* This is a key objective of the GSV. Site noise is initially determined at the IVS to confirm that targets of interest can be distinguished from site noise. Site noise should be monitored continually in the production geophysical data to determine if changes in site noise will require reevaluation of the data analysis procedures or target selection criteria.

*Verify signal levels.* Signal strength and sensor performance are initially demonstrated by dynamic tests on the instrument verification strip prior to production mapping. To verify the translation into the field production data, the signal levels for the seed targets can be compared to expected values. Anomalies that correspond to the seed targets should be selected in the anomaly selection process and appear on the dig list. In the case where they do not, this would trigger a root cause analysis.

*Approval to proceed.* It has been common practice for approval to proceed on the production work to be contingent on a successful GPO, where success included detecting all the seeded targets and illustrating that the data met specifications. In the GSV, this would be based on instrument verification strip and noise measurements, contingent on a quality check of first lot (in the range of half a day) of production data, where it will be established that the data collection is achieving all DQOs on the field site. DQOs and decision criteria for proceeding would be set in advance, and the quality review would be done in time to allow corrective action and to support a decision in hours rather than days or weeks.

*Confirm anomaly selection criteria.* Site-specific anomaly selection criteria will be defined by many factors, including known sensor response, regulatory requirements, land use and overall project objectives. Each of these factors will be considered as DQOs are developed to define the selection criteria.

- The IVS data and initial noise measurements will validate the predetermined target selection criteria and determine whether the noise will allow for detection of all targets in the project objectives.
- Seeds placed throughout the production site will assist in confirming that anomaly selection criteria have been followed throughout the course of geophysical mapping, anomaly reacquisition, and anomaly resolution. Seeds will verify that the targets that meet the criteria are selected or guide modification of the criteria.
- Continual monitoring of the data will ensure that site background noise is not approaching or greater than the anomaly selection criteria. Ongoing monitoring of site

noise will either confirm that the selection criteria should detect all targets of interest, or inform decisions in areas where the higher noise levels will hamper detection.

*Evaluate contractor data analysis procedures.* Processing of geophysical data has many steps, including merging the sensor location and response data and filtering and smoothing, as well as identifying data problems and applying other corrections or removing problem data. Ultimately, target selection is performed on the end product of this sequence of data manipulation steps. Analysis procedures should leave targets with appropriate anomaly characteristics and correctly located. ISOs can be used to identify problems along this route that need to be corrected. The IVS will provide a limited check on contractor data analysis, and blind seeding will serve as an important end-of-process monitoring tool. Seeds should be selected as targets and should display signals consistent with the sensor response curves and past measurements. In addition, production data can be evaluated to confirm that the entire data processing flow results in a product consistent with DQOs. It is suggested that this be done on a daily basis with turnaround times short enough to allow for prompt identification of problems and timely corrective actions.

*Demonstrate anomaly resolution.* Seed items will test this objective. Seeds are blind to the data collection, processing, and field digging crews. To verify anomaly resolution criteria and procedures, the seeds should be placed on the dig list and dug up like any other detected object. The project geophysicist will review the results of each excavation and determine if the item recovered is consistent with the geophysical signature of the anomaly identified in the geophysical survey. This is referred to as the “feedback process.” Since the seeds are known objects at known locations, they provide a constrained test of reacquisition procedures. They will be encountered at some predetermined frequency throughout the production work to provide ongoing monitoring. In addition, similar evaluation of the resolution of all unknown anomalies in the production data should be standard practice, to determine if recovered items are consistent with the geophysical signature from the survey.

Several objectives of the GPOs will require evaluation of the production geophysical data. In the past, DQOs were established, then data were collected at the GPO and evaluated to determine if the DQOs were being met, assuming the GPO data were representative of the quality achievable during production mapping. An instrument verification strip approach limits the usability of these data for this purpose. We contend that data quality is best monitored in the production field data; GPO data are not always representative of production mode data collected in field conditions with production field teams over the life of the project.

Table 5-2 summarizes this additional quality monitoring, with a focus on enhancements to common procedures and essential elements that may be in use today but are required to meet the above objectives. A thorough evaluation of the first day’s production data is required to address several of these GPO objectives. Data analysis should be completed and documented and can serve as a “certification” for the data collection team to continue production work at the site. Criteria to proceed and the needed documentation should be decided in advance. It is envisioned that this documentation would not be a formal report, but more resemble a check list of essential quality control measures that could be filled out on site to support mobilization the same day or the next morning. Some common geophysical data evaluation software packages, including Oasis Montaj, include automated methods for several of these QC checks such as line spacing and point density.

**Table 5-2. Summary of Recommended QC Enhancements for GSV**

Recommendation	Purpose
Monitor Signal Levels	<ul style="list-style-type: none"> <li>• Signal levels from seeds must be within expected band.</li> </ul>
Monitor Noise	<ul style="list-style-type: none"> <li>• Noise in production lots monitored daily for changes in equipment or operators.</li> <li>• Compared to test strip noise measurement.</li> <li>• Determine if change in site noise requires re-evaluating data analysis procedures (filtering) or target selection criteria.</li> </ul>
DQO Compliance—Initial and Daily	<ul style="list-style-type: none"> <li>• Appropriateness of line spacing confirmed from first day’s IVS measurements.</li> <li>• Line spacing and point density monitored daily.</li> </ul>
Monitor Position Accuracy	<ul style="list-style-type: none"> <li>• Seed items interpreted within project-specific requirements.</li> </ul>
Feedback Process	<ul style="list-style-type: none"> <li>• Seed items recovered as expected by dig team.</li> <li>• All recovered items examined to confirm match to observed data.</li> </ul>

Data evaluation may be the responsibility of one of a number of project participants, depending on the project. Overall, the performer must take responsibility for the quality of all data, but the customer or its representative should review the initial quality monitoring and may examine a subset of the data throughout the life of the project. These will be project-specific decisions. Following the initial data evaluation a daily check of, at a minimum, a sample of the data for each team should be evaluated to ensure consistent data quality. Temporal trends in the data should be analyzed to identify potential problems before data fail to meet specifications.

## **5.2 ADDED BENEFITS OF GSV**

The GSV process outlined here is both straightforward and rigorous. It redirects resources from a traditional GPO to a quantitative and transparent evaluation of data quality that spans the life of the project. Some additional advantages include:

*One deployment.* The current GPO is expensive, in part because it often involves one deployment to construct the GPO and collect the data, followed by an interval in which a formal report is written, reviewed and approved. This is not necessary. With advanced planning based on an understanding of the geophysical equipment, the essential items could be verified on site in a timely manner to support a single deployment. Conditions must be outlined in detail in advance, including metrics and success criteria. If GSV is completed successfully, approval to proceed could be immediate. If problems are encountered, the information generated in the IVS, noise measurements, and evaluation of initial data collection would be useful for root cause analysis and corrective action.

*Can be standard across sites.* GPOs have always varied considerably in size, number and selection of targets, and evaluation criteria. This has made it difficult to compare data from one GPO to another. Whether the targets were inert munitions or other objects like pipes or spheres,

none was ever well characterized and did not support any type of quantitative interpretation. Using the response curves generated for both the proposed ISOs and common munitions, it is now possible to establish a minimum of standardization across sites, while recognizing that individual site teams may want to add to what is presented here.

*More rigorous.* What it means to “see” a target in a GPO is not well defined. Analyzing a small data set to prove that targets are detected at their most stressing depths offers the temptation to “pick into the noise” or take other extraordinary measures to put a detection on the list for seeds that are really not detectable under production conditions throughout the site. Detectability is determined by target signal and noise, both of which are carefully measured in the GSV to provide quantitative results that will establish realistic expectations of performance.

*Enhanced ongoing feedback.* Daily visits to the IVS before and after the production work will provide quantitative checks on signal and noise consistency in a known location. Blind seeds, emplaced at intervals to provide a minimum of one seed in each day’s data collection, provide ongoing evidence that the entire data collection and analysis process is working. Seeds should be detected at correct signal levels and placed on the dig list. Monitoring of noise in production data ensures that either expectations of detection performance will be met or that changes in noise conditions are recognized and appropriate adjustments made. Taken together, these elements of the GSV lead to confidence that data throughout the project is meeting project objectives.

## 6.0 REFERENCES

1. Defense Ammunition Center (DAC) U.S. Army Technical Center for Explosive Safety (USATCES). 2000. "Study of Ammunition Dud and Low Order Detonation Rates." SFIM-AEC-ET-CR-200049. July 2000.
2. Environmental Security Technology Certification Program, Interstate Technology and Regulatory Council, and Strategic Environmental Research and Development Program. 2006. "Survey of Munitions Response Technologies." June 2006.
3. Nelson, H.H., T. Bell, J. Kingdon, N. Khadr, and D. Steinhurst. 2009. "EM61-MK2 Response of Three Munitions Surrogates." NRL/MR/6110-09-9183. March 12, 2009.
4. Nelson, H.H., T. Bell, J. Kingdon, N. Khadr, and D. Steinhurst. 2008. "EM61-MK2 Response of Standard Munitions Items." NRL/MR/6110-08-9155, October 6, 2008.
5. Harbaugh, G. R., D.A. Steinhurst, and N. Khadr. 2007. "MTADS Demonstration at Camp Sibert Magnetometer / EM61 MK2 / GEM-3 Arrays." Demonstration Data Report. September 26, 2007.
6. Gamey, J., and R. Selfridge. 2000. "Analysis of Common Geophysical Acquisition Problems," UXO/Countermines Forum, Anaheim, May 2-4, 2000;
7. Boler, K., and M. Miele. 2006. "Motional Noise in TDEM Data: EM61-MK2 Examples and Implications," Nineteenth Symposium on the Applications of Geophysics to Environmental and Engineering Problems (SAGEEP), Seattle, April 2-6, 2006.
8. Interstate Technology and Regulatory Council. 2004. "Geophysical Prove-Outs for Munitions Response Projects." November 2004.
9. U.S. Army Corps of Engineers. 2007. "Engineering and Design - Military Munitions Response Actions." EM 1110-1-4009. June 5, 2007.
10. Interstate Technology and Regulatory Council. 2008. "Quality Considerations for Munitions Response Projects." October 2008.





## APPENDIX A: APPLICATION TO AN EXAMPLE SITE

This appendix will serve as an example of the application of the methods discussed in this report. All of the data presented here are real data collected on a site configured as specified. The discussion here is not intended to be a template to be applied to all projects. The particulars for any individual project may be different from this example and will be determined from the data quality objectives appropriate to that project.

The example site to be considered is a 100-hectare (250-acre) site that is part of a former bombing and gunnery range. After remediation, the site is slated for residential development. The historical records indicate a variety of munitions were used on the site, but the two that are of primary concern are 37-mm projectiles and 3-lb practice bombs. Since the targets of interest are relatively small and are not expected to be more than 1 foot deep, the site team has chosen the EM61-MK2 as the geophysical survey instrument to be used at this site with a survey lane spacing of 0.6 m. The site is an open field with good sky view throughout so the Global Positioning System (GPS) is the choice for sensor location. A summary of the data objectives established for this site is given in Table A-1.

**Table A-1. Data objectives for the example site**

Parameter	Objective at this Site
Geophysical Instrument	EM61-MK2 on standard wheels
Geolocation System	RTK GPS (cm-level)
Depth of Interest	30 cm (1 ft)
Survey Lane Spacing	60 cm
Gate for Primary Data Analysis	Gate 2
Anomaly Amplitude Reproducibility	± 20%
IVS Item Position Reproducibility	± 25 cm
Seed Position Reproducibility	± 50 cm

### A-1 ESTABLISH ANOMALY SELECTION CRITERIA

The anomaly selection criterion at this site will be based on the smallest signal expected from the targets of interest at the depth of interest (1 ft or 30 cm bgs at this site). Anomalies will be selected using the gate 2 data from the EM61-MK2. The predicted signals for the two primary targets of interest as a function of depth are shown in Figure A-1. From these curves, we can determine that the smallest signal expected from a 37-mm projectile at 30-cm depth is 5.2 mV when the item passes directly under the center of the sensor and 16.6 mV for the 3-lb practice bomb under the same conditions. Since the 37-mm projectile is expected to produce the smaller signal at 30-cm depth, anomalies will be selected based on the signal from that target.

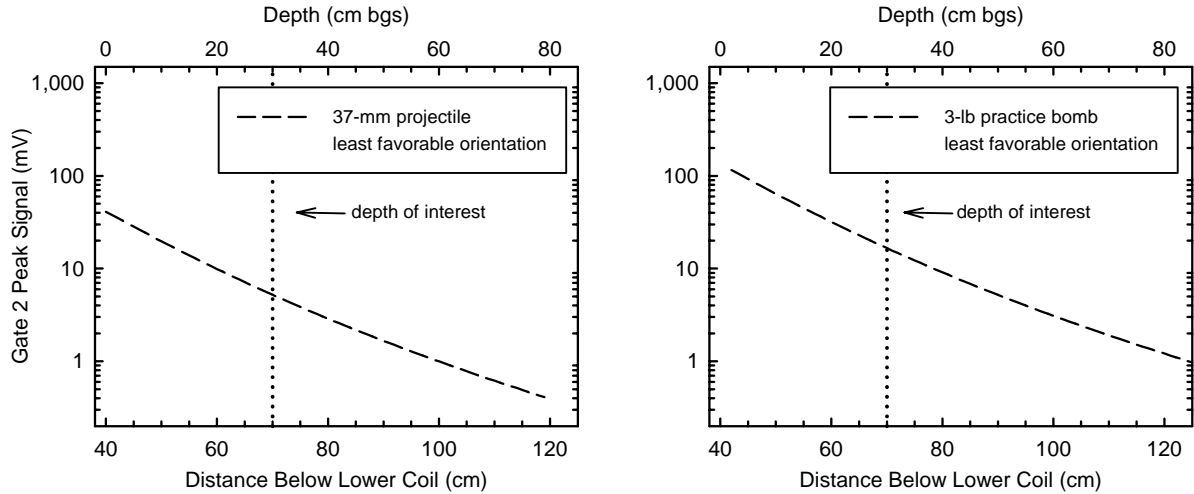

**Figure A-1. Predicted EM61-MK2 gate 2 response of a 37-mm projectile (left panel) and a 3-lb practice bomb (right panel)**

Figure A-2 shows the magnitude of the signal fall-off for items that are not directly under the center of the sensor. The dotted lines mark the largest amplitude difference expected from the 30-cm offset possible when a 0.6-m line spacing is used. These data show that the signal measured in a real survey can be expected to be as much as 16% lower than the centerline anomaly amplitudes plotted in Figure A-1. To account for this possibility and other sources of signal degradation, the site team has decided to apply a 50% safety margin to the values in Figure A-1. This results in an anomaly selection threshold of 2.6 mV.

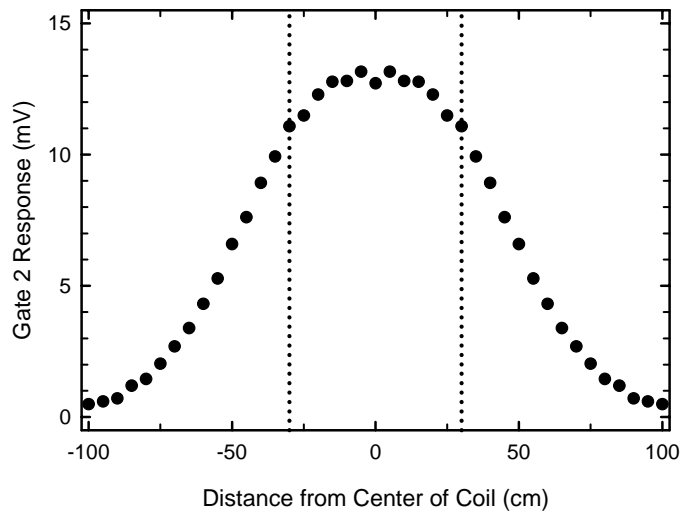

**Figure A-2. Anomaly amplitude as a function of cross-track position for an item under an EM61-MK2. The vertical dashed lines represent the largest offset expected for a survey line spacing of 0.6 m.**

## **A-2 INSTRUMENT VERIFICATION STRIP**

As discussed in the document, the objective of the instrument verification strip is to confirm the geophysical survey instrument selection, verify that the targets of interest will be detectable to

the depth of interest at this site, validate predetermined anomaly selection methods, and provide a daily verification of proper operation of the geophysical sensor system (sensor plus location system plus data recording approach).

### A-2.1 ESTABLISHMENT OF THE IVS

The first task in planning the instrument verification strip is to decide what items will be emplaced. The site team at this site decided that since the smallest, most difficult to detect item of interest is a 37-mm projectile, the IVS would contain two inert 37-mm projectiles and four small industry standard objects (ISOs) to serve as surrogates during the seed program. They will be placed in the IVS at two depths (3X and 7X their diameter) and two orientations, as reflected in Table A-2. Note that the deepest depth chosen is close to the maximum depth of interest at this site but that was not the reason for the choice. The goal of the IVS is to verify twice each day that the geophysical system is working correctly. To accomplish that with reasonable precision requires a high signal-to-noise ratio (SNR) on the sensor measurements. The two depths were chosen to ensure that the required SNR is achieved.

**Table A-2. Instrument verification strip definition for the example site**

Item	ID	Position (m)	Depth to Item Center	Orientation
1	Small ISO*	2.5	11 cm (3X)	Horizontal across track
2	Small ISO	7.5	26 cm (7X)	Horizontal across track
3	37-mm Projectile	12.5	11 cm	Horizontal across track
4	37-mm Projectile	17.5	26 cm	Horizontal along track
5	Small ISO	22.5	11 cm	Horizontal along track
6	Small ISO	27.5	26 cm	Horizontal along track

\* The small industry standard object is a Schedule 40, 1" straight pipe nipple (1.315" [33 mm] OD), 4" [10.2 cm] long.

The items to be emplaced are relatively small so the spatial extent of their signatures will not be large, but an ancillary purpose of the IVS is to get a measure of site-specific survey noise. With this in mind, the site team decided to emplace the IVS items with spacing of 5 m, leaving 2.5 m clear on each end of the strip. This results in an IVS approximately 100 ft long. The geophysical contractor will choose an area on the site that contains representative terrain, geology, and vegetation. The area should be of appropriate size, e.g., a clear strip 30 m long and 5 m wide, which affords convenient access. Any arrangement or orientation of the IVS is satisfactory; a linear configuration was chosen because it is convenient at this site.

The test items will be buried as specified in Table A-2 and as sketched in Figure A-3. The actual locations of the test items will be recorded to a precision appropriate to the location system being used. Since a cm-level GPS system is being used at this site, the locations and depths will be recorded to within 2 cm.

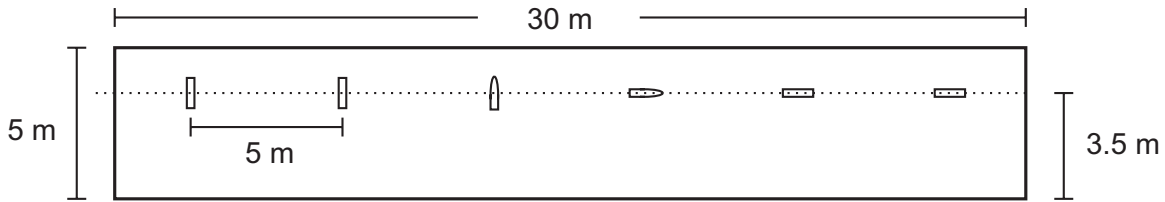

Figure A-3. Sketch of the IVS layout for this site

## A-2.2 FIRST DAY'S DATA COLLECTION

One of the goals of the approach outlined here is to qualify the methods to be used by the geophysical contractor and begin actual survey work with only a single deployment to the site. To accomplish this, the initial survey of the IVS is designed to confirm both the operation of the survey system and the ability of the chosen sensor to detect the items of interest at the depth of interest in the noise environment particular to the survey site. This means the initial data collection over the IVS is more extensive than later passes over the strip will be.

The expected timeline for the first use of the strip involves the geophysical contractor arriving on the site the first day of operations, identifying a location for the IVS in conjunction with the program manager, conducting a background survey to identify a site suitable for an IVS, and emplacing the test items according to the specification in Table A-2. If the strip location is not very cluttered, this may still leave time for an initial survey on the first day at the site; if not, the strip can be surveyed at the beginning of the second day on site.

Figure A-4 is a sketch of the protocol for this first survey. The first pass of the 1-m wide by  $\frac{1}{2}$  m EM61-MK2 is made with the sensor 0.6 m offset from the test item burial line. The site team has determined that a line spacing of 0.6 m is appropriate to ensure detection of the 37-mm projectiles. The next pass is directly over the test items. This will allow the data analyst to determine the maximum signal expected from each item. To confirm the 0.6-m line spacing, the survey crew makes a third pass with an offset of 0.3 m (one half of the planned line spacing—the maximum offset of any target from the center of a survey line) and a fourth at an offset of 0.6 m. The final pass is 2 m offset from the line of targets to make a measurement of survey noise at this location.

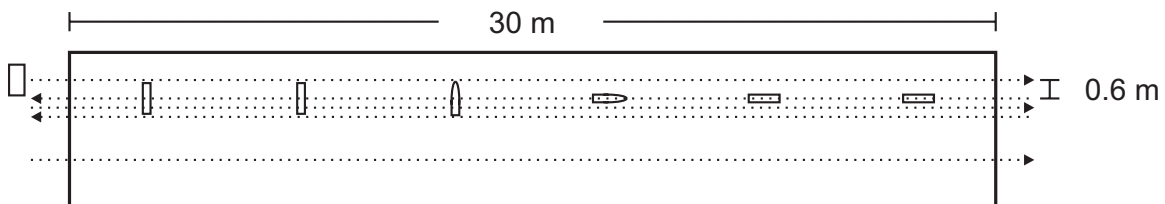
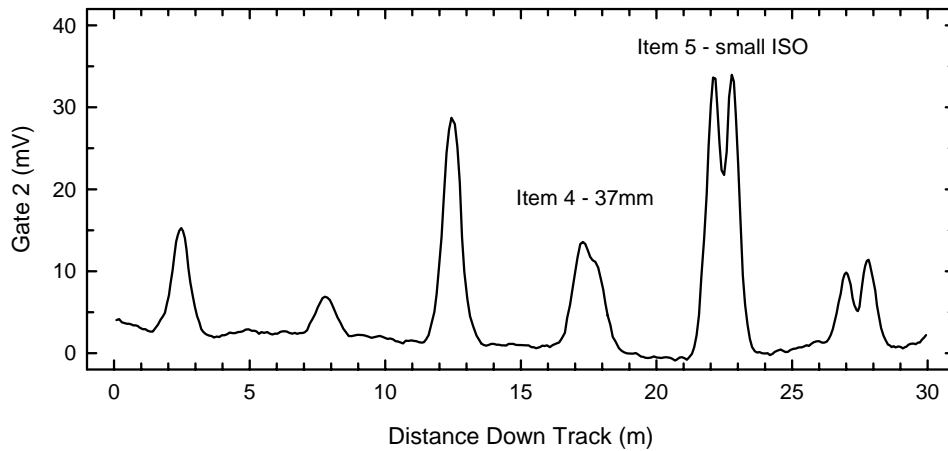

Figure A-4. Sketch of the survey protocol for the first data collection at the IVS

There are several components of the first day's submission that will result from analysis of the geophysical data collected during this initial survey. The first step is to compare the signal strengths measured over each item in the IVS to those predicted, which confirms proper operation of the sensor. Comparison to the RMS noise measured at the site will confirm the detection requirements of the project can be met. A trace of the measured data from the line

directly over the targets is shown in Figure A-5. As in all cases in this appendix, these are actual field data measured over an IVS constructed as specified in Table A-2.



**Figure A-5. Measured data from the line passing directly over the IVS items**

Each of the items is detected with good SNR and the teams’ choice of 5-m spacing between the items is confirmed; each anomaly returns to the baseline, and there is a good section to measure noise between the anomalies. Notice that items 4, 5, and 6 display the familiar double-humped profile that is the signature of long targets aligned along track as was discussed in Chapter 2. Items 5 and 6 are the symmetric ISOs and exhibit a very clean double-peaked profile. Item 4, the 37-mm projectile, is less symmetric (the nose is much smaller than the back of the projectile) with the response from the back larger than that from the nose, making it more difficult to establish the location of the center dip.

A trace of the measured data from the “noise” line is plotted in Figure A-6 on the same scale as Figure A-5 with an inset at a higher magnification. There may be a small scrap item remaining about 4.5 m down the line but, otherwise, the contractor team has done a good job identifying a target-free area for the noise measurements. Although the magnified portion is relatively quiet, analysis of the entire trace yields an RMS noise of 0.25 mV or 1.5 mV peak-to-peak.

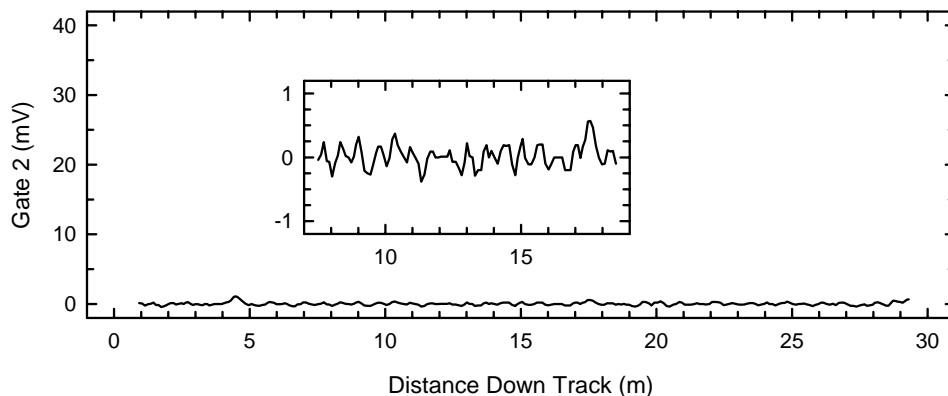

**Figure A-6. Measured data from the line offset 2 m from the IVS items**

The measured anomaly amplitude in gate 2 for the two 37-mm projectiles and the RMS noise are compared to the predicted responses in Figure A-7. The dashed curve corresponds to the signal expected when the item is in its most favorable (vertical) orientation, and the solid curve

corresponds to expected signal when the item is in its least favorable (horizontal) orientation. Both 37-mm projectiles in the IVS are oriented horizontally, so their signals should be close to the solid curve if the sensor is operating normally, which it is in this case.

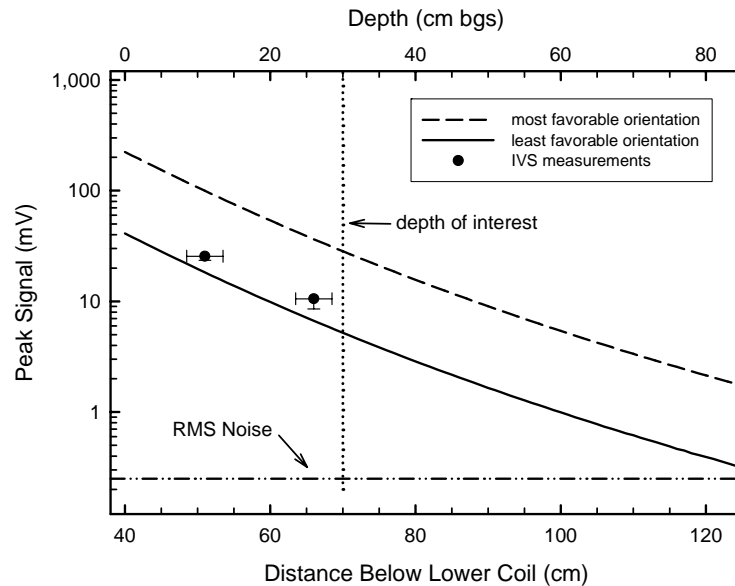

**Figure A-7. Calculated response in gate 2 of an EM61-MK2 for a 37-mm projectile in its most and least favorable orientations, the survey noise measured at the site, the signal measured over the two projectiles in the IVS, and an indication of the depth of interest for this item at this site. The error bars correspond to a 2.5-cm (1") uncertainty in the burial depth and 2x the measured amplitude noise.**

From the site noise data shown in Figure A-7, the site team can confirm that the detection requirements for this item at this site can be met. The depth of interest for the 37-mm is 1 ft or ~30 cm. That, added to the 40-cm height of the sensor coil above the ground, means that detection will be limited by the signal expected at 70-cm distance from the coil to the item. The minimum signal in gate 2 expected from a 37-mm projectile at this depth is a little over 5 mV. The measured survey noise in this gate at this site is 0.25 mV resulting in a minimum signal-to-noise ratio of almost 20, which is well above the requirements for detection.

The second objective to be checked from the first day's data is the performance of the sensor geolocation system. One method to accomplish this is to find the position of the peak signal for each object (or in the case of targets located along track, the center of the double-humped profile) and compare this to the known locations of the targets. Since the GPS system used at this site measures the position of the center of the EM61 coil, this cross-track location accuracy is limited by how carefully the sensor operator positions the center of the coil directly over the line of items in the IVS. In this case, the operator was very careful, resulting in the measured position deviations plotted in a polar plot in Figure A-8. The IVS at this site is laid out E-W so, as expected, the greatest deviations are in the cross-track (N-S) direction. Had any of the deviations been larger than the objective of 25 cm, corrective action would have been required before approval to proceed was given.

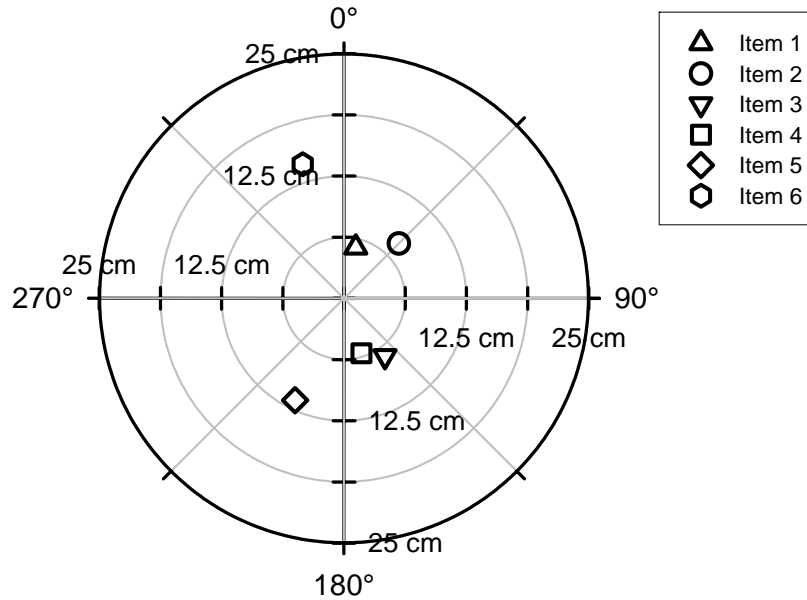

**Figure A-8. Plot of the deviations in positions of the six IVS items, as determined from the profile shown in Figure A-5 from the known positions. The survey direction is E-W.**

A better method to determine the geolocation performance is to take advantage of the extra survey passes on the first day and invert the geophysical data for the item's position. The data corresponding to the passes at offsets of -60, 0, and 60 cm are presented as an interpolated image in Figure A-9. Each anomaly in the data is selected by the data analyst using that contractor's standard methodology and, at a minimum, analyzed for location. As above, these derived locations are compared to the ground truth recorded during emplacement.

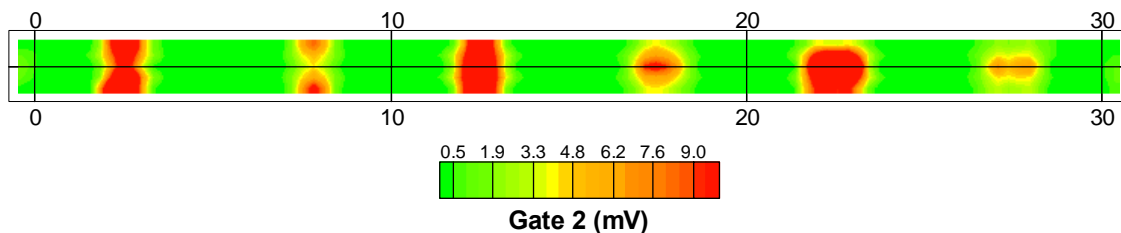

**Figure A-9. Interpolated anomaly image constructed using the data from the passes with offsets of -60, 0, and 60 cm**

The deviations of the fitted positions from the emplaced values are plotted in Figure A-10. The agreement with the measured positions is better in this case; the largest deviation observed is just under 10 cm. As expected, the deviation in Easting is quite small; this is the down-track direction where the sampling interval is ~10 cm. The across-track sample spacing is limited by the survey line spacing of 60 cm, and the deviations in this direction are consequently larger.

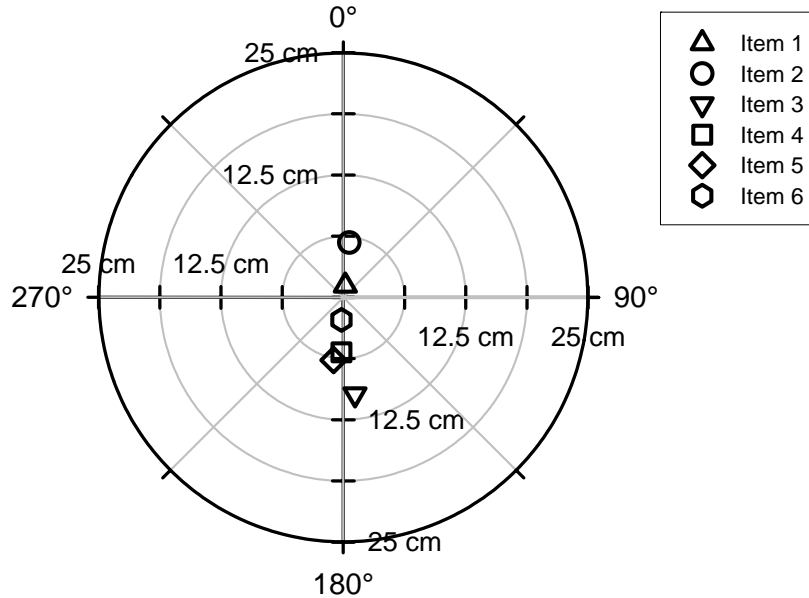

**Figure A-10. Plot of the deviations in the fitted positions of the six IVS items from the known positions. The survey direction is E-W.**

The final thing to be confirmed from the first day’s data is the survey lane spacing specified in the project plan. If the survey line spacing is 0.6 m, no target should pass further than 0.3 m from the center of the sensor. The signal decrease expected for this offset was taken into account when the anomaly selection criterion was established above; this measurement is only intended to confirm our predictions. The signals measured for each item for the pass directly over the items is compared to the 0.3-m offset pass in Table A-3. From these results, it is clear that a 0.6-m lane spacing is appropriate for detection of the items-of-interest.

**Table A-3. Comparison of peak gate 2 response directly over the 37-mm projectiles to those offset by 30 cm in the cross track direction**

Item	ID	Depth to Center	Orientation	Peak Signal On Center (mV)	Peak Signal Offset by 0.3 m (mV)
3	37-mm Projectile	11 cm	Across Track	25.5	30.1
4	37-mm Projectile	26 cm	Along Track	10.5	9.8

Notice from Table A-3 that the signal for item 3 is larger in the offset pass as is expected for an item oriented across track (see discussion in Section 2). The signal fall-off for the 37 mm oriented along track is well within that expected (compare Figure A-2).

After each of the items discussed in this section have been submitted to the site team, it will be straightforward for the team to agree that the operator’s equipment and procedures meet the data objectives and give permission to proceed with the geophysical survey.

### **A-2.3 DAILY PERFORMANCE CONFIRMATION**

In addition to whatever function tests the contractor performs each day to ensure proper operation of their survey equipment, each survey crew will be required to survey the IVS at the



beginning and end of each day. This will be a simplified survey, as illustrated in Figure A-11— one pass over the line of emplaced targets to confirm sensor operation and one pass to confirm that the survey noise has not changed. If the sensor performance and system noise are within specifications before and after each day of surveying, it is reasonable to expect that the system was performing within acceptable bounds throughout the day. If the sensor performance is within performance criteria in the morning and not in the evening, the data must be examined to determine if any of it is usable.

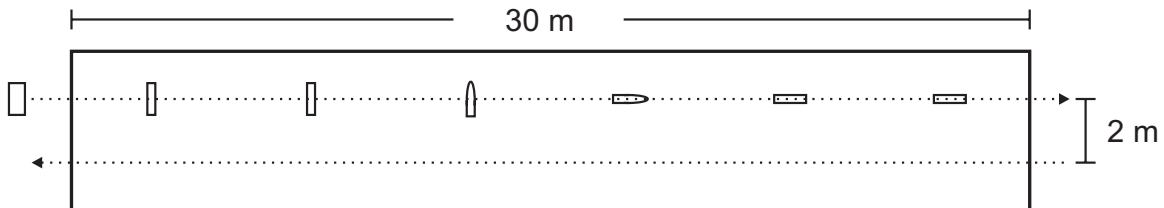

**Figure A-11. Sketch of the survey protocol for the twice daily performance confirmation surveys at the IVS.**

The results of these twice-daily performance confirmation surveys will be reported in a continually updated set of plots showing the down-track position error and amplitude variation for each target as illustrated in Figures A-12 and A-13. As with the first day’s measurements, any deviations outside the data objectives will require a detailed root cause analysis before survey operations can be resumed.

Notice in Figure A-12 that the measured down-track position of Item 4 appears to have an offset from the known value. This arises from the difficulty in determining the center of the signal for this item as was seen in Figure A-5 and illustrates the advantages of the standard targets for the IVS. Item 2 displays a smaller systematic offset.

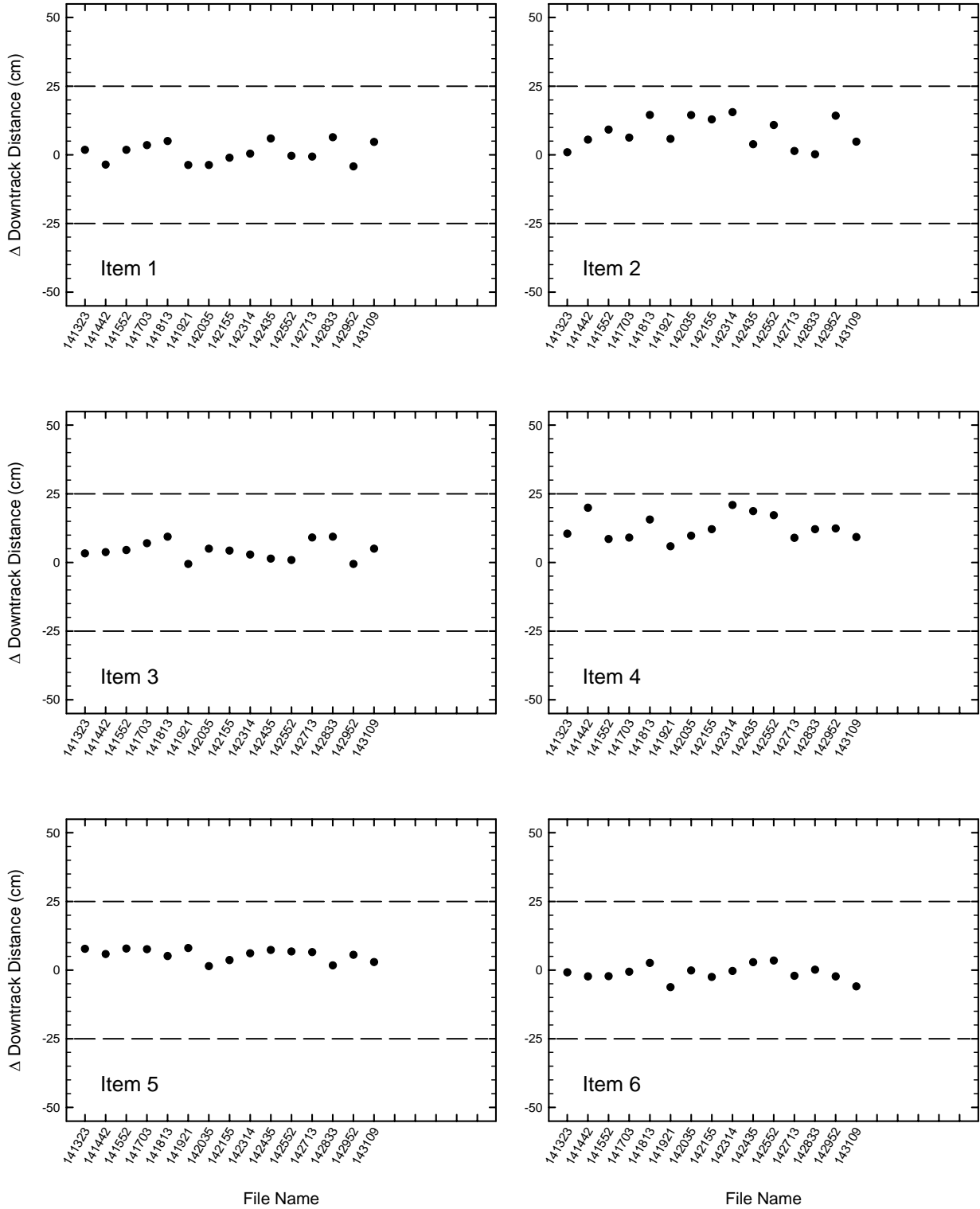
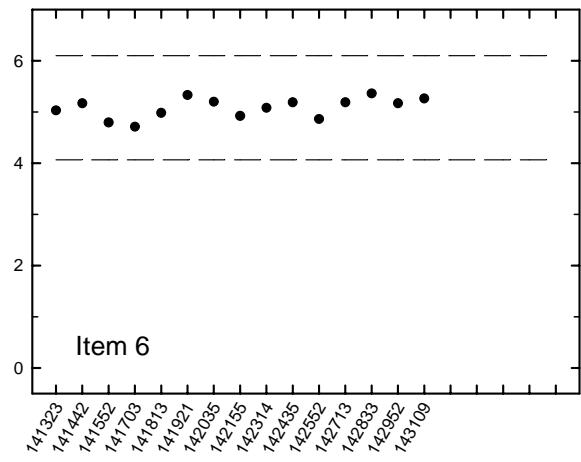
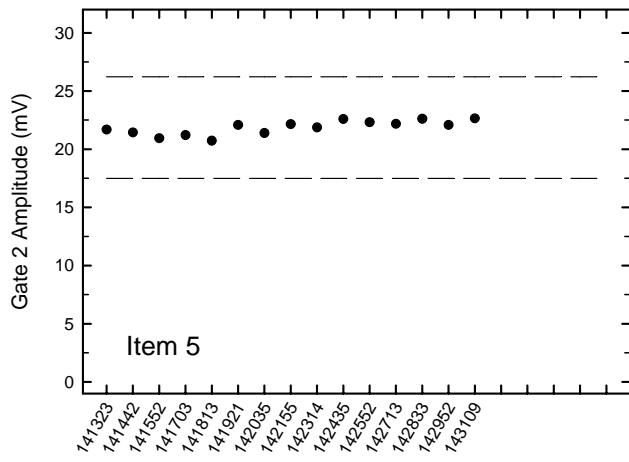
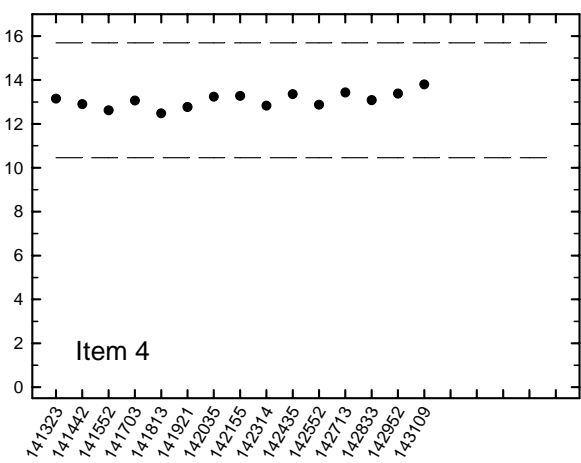
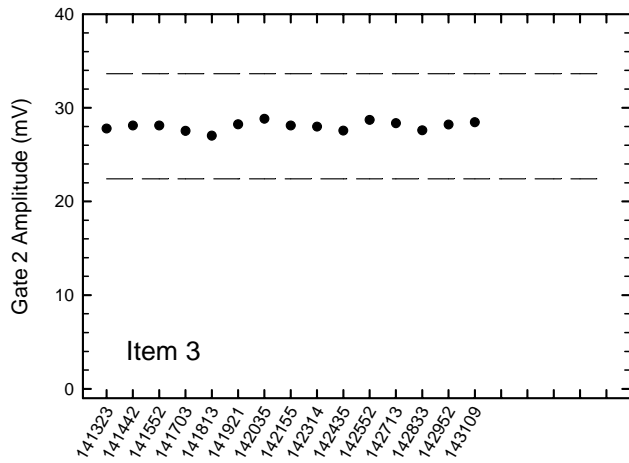
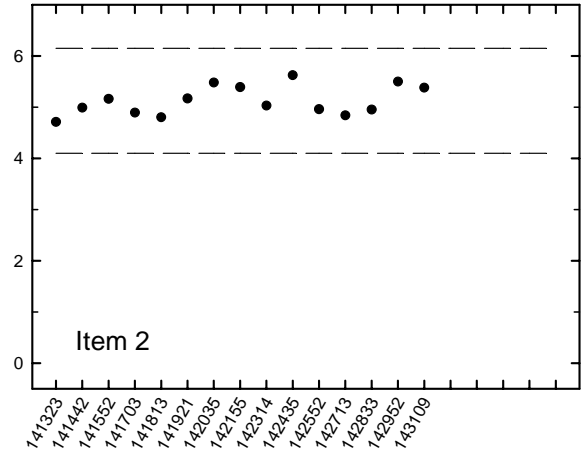
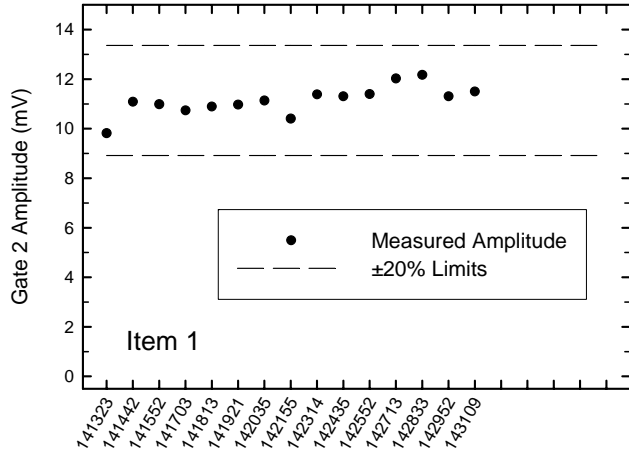

Figure A-12. Twice daily variation of down-track position for the items in the IVS. All measured points (circles) are within 25 cm (dashed lines) of ground truth.



File Name

File Name

Figure A-13. Twice daily variation of measured signal amplitude for the targets in the IVS. All measured signals (circles) within 20% of the mean as indicated by the dotted lines.

## **A-3 PRODUCTION BLIND SEEDING**

As one part of the QC plan for this site, the site team has hired a third party to design and implement a blind seed program in the production survey areas. This seeding is only one component of the QC plan for the site; the blind seeds will be used to verify that the DQOs concerning geolocation, sensor performance, anomaly selection, and anomaly resolution requirements are being met.

The site team has demonstrated that, of the two targets of interest, the 37-mm projectile is the more difficult to detect and therefore has chosen to base the blind seeding on that item. To avoid the problem of acquiring a sufficient number of inert projectiles and of possibly leaving one or more on the site, the small ISO that was emplaced in the IVS will be used for blind seeding. These items are available off-the-shelf for less than \$2.00 each in small lots, so procurement of a significant number is possible within the site budget.

### **A-3.1 EMPLACEMENT OF BLIND SEED ITEMS**

The site has been divided into 30-m x 30-m (100' x 100') grids. Under the conditions at this site, each survey team covers six grids per day. The site team has determined that to adequately measure the performance of each team, they will require a seed in half the grids in addition to any seeding the performer employs for their own quality program. This means ~600 seed items will be required. One-third of the seeds will be placed at 11 cm as in the IVS, one-third at 20 cm, and one-third at our depth of interest, 30 cm, in random orientations with all measurements corresponding to the center of the item. Twenty-five of the shallow seeds will have an additional seed placed under them for the purposes of confirming the anomaly resolution process (stacked seeds). In addition to this, three seeds will be placed in the first grid surveyed by each the crews.

The seed items will be randomly placed within each grid scheduled for a seed. A small number may be added in particularly challenging locations to better monitor performance in the extremes. The random seed locations will be chosen in advance but the emplacement team will utilize anomaly avoidance techniques for both safety and to make the analysis of results more straightforward. No seed will be placed within 25 cm of a significant, existing anomaly or a tree.

After emplacing the seed, the emplacement team will record the location of the center of the seed using an RTK GPS and the depth below ground surface to 2 cm. The team will then return the burial location to a natural look.

### **A-3.2 EVALUATION OF PERFORMANCE**

Performance evaluation against the seeds can, in principle, be done by the performer or a third party employed for this purpose. The only requirement is that the seeds be blind to the personnel collecting the data, analyzing the data, and selecting targets for the dig list. At this site, a consultant geophysicist has been hired to oversee the blind seeding program, and the performer has chosen to plant some additional, non-blind seeds for their own quality program.

As the data from each grid are analyzed and targets selected, this information will be transmitted to the consulting geophysicist. For each grid that contains a seed, she will determine whether the seed(s) made it to the target list. If so, she will ensure that the signal strength and location accuracy are within contract specifications and, after the anomaly has been dug, make sure that

the correct item (or items if this was a stacked seed) is recovered. If the seed is not on the target list, she will begin a root cause analysis. Questions to be asked include: Is there a geophysical signal at the seed location that should have been picked? Is there an anomaly but is it below the selection threshold? Is there an anomaly remaining that was below a more shallow anomaly (stacked seed)? Is there a sensor location issue?

Products from the performance analysis will be analogous to those generated from analysis of the IVS data; plots of signal strength and location accuracy updated as seeds are encountered. Example plots are shown in Figures A-14 and A-15.

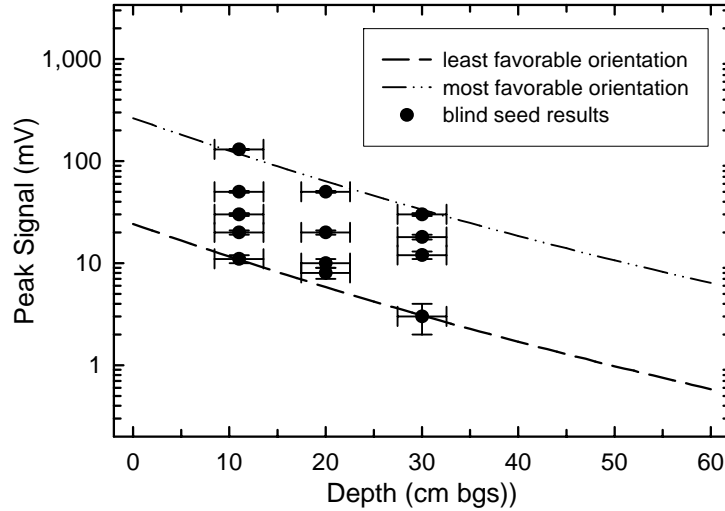

Figure A-14. Cumulative plot of anomaly amplitude for seeds encountered in the survey. The error bars on the measured points correspond to  $\pm 2.5$  cm (1") for depth errors and twice the measured site noise.

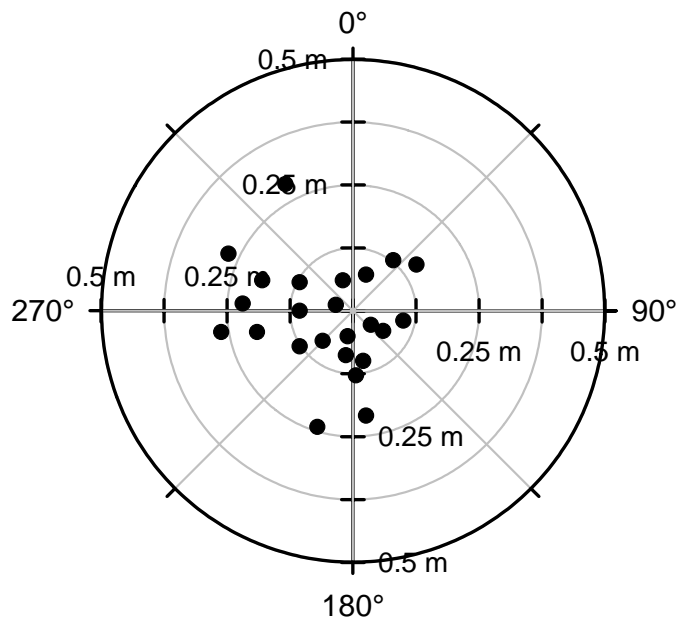

Figure A-15. Cumulative plot of location accuracy for seeds encountered in the survey. A bias to the west is beginning to be manifest in the data. A root cause analysis is indicated.



## **APPENDIX B: FREQUENTLY ASKED QUESTIONS**

### **Why should I use the physics-based process?**

The physics-based approach represents a rigorous, transparent, and timely process to accomplish the historical GPO functions while allowing for ongoing monitoring of the quality of the production work. By using a small instrument verification strip (IVS) for daily confirmation that the geophysical system is performing as expected (based on years of measurements at standard test sites and countless production projects), project resources can be shifted from construction of an elaborate GPO into a site-wide blind seed program. The performance of all survey teams over these blind seeds can be evaluated on an ongoing basis by all stakeholders, performer, customer, and regulators. As an added benefit, the performer can conduct an initial survey of the IVS, report their results, and be cleared to begin production work during one deployment to the site, saving the expense of an extensive GPO report and two deployments before production work begins.

### **Why wouldn't I just use a GPO?**

In the early days of munitions response, there was often uncertainty about which technologies were applicable at a particular site and what the capabilities of those technologies were. GPOs evolved to attempt to answer some of these questions. GPOs, however, are expensive and time-consuming, and often do not supply the information that a site team thinks they are getting when they specify one. For example, GPOs are unlikely to contain enough targets to result in a statistically significant measure of system performance, and they do not measure performance day by day under all conditions at a site.

Fortunately, the last 15 years of work have answered many of the initial questions. The commonly used geophysical sensors are now well understood and their performance can be predicted with confidence. The process outlined here replaces the GPO with a small instrument verification strip used to verify correct operation of the sensor system each day and a blind seeding program that measures performance of the total survey, analysis, and anomaly resolution process on an ongoing basis.

### **In what situations would you still want to use a GPO?**

The premise of this approach is that the basic physics of the sensor system is well characterized and well documented. This approach will not be applicable to so-called “black boxes.” This will include proprietary devices for which sensor details are not divulged, and any other system whose operation, in terms of both hardware and processing, is not well-documented. It will not be appropriate for technologies based on completely different physical phenomena, where a GPO may be required.

The physics-based approach relies on the ability to demonstrate that a measured signal for a known object is consistent with physical model predictions and prior measurements, and further that the signal is detectable above measured site noise. Both of these factors require a digital record of geolocated instrument readings. Approaches such as mag and dig, which rely on an operator making real-time decisions interpreting an analog signal, do not produce

such a record. Although some aspects of this approach may be transferable to projects based on analog technologies, care should be taken, as it was not conceived with that approach in mind.

### **What is the minimum required for an instrument verification strip?**

A minimum of one item in an instrument verification strip is required to demonstrate that the geophysical sensor and location system are working properly. This is accomplished by comparing the measured anomaly amplitude from the object to the physics-based predictions and the derived location to the known emplacement location. Most site teams will want to have more than one item (four to ten), as more items can be added for little added cost. Since the IVS is not a statistical process, a large number of items is not required.

### **What are the sensor response curves based on?**

The sensor response models presented in this document are based on physics-based models of the response of total-field magnetometers and time-domain EMI sensors to common munitions items. These models have been developed and validated over the past 10 years in research programs sponsored by SERDP and ESTCP. Their predictions have been verified by 15 years of measurements at test sites and on munitions response sites.

### **Is detection performance site-specific?**

Yes. Detection performance depends on two elements: (1) The response of a geophysical sensor to a specific item of interest at a defined depth and orientation is site invariant and can be predicted in advance. (2) The system noise is site-specific and will depend on local geology, terrain, clutter environment, and external fields. Once the site-specific noise is measured it is straightforward to determine if the sensor under consideration will be able to reliably detect the items of interest at depth.

### **What is “noise” and how is it measured?**

Total system noise is defined as any variations in the sensor output that are not associated with a discrete metal item. It is the sum of intrinsic sensor noise (which is often small compared to the other noise sources) and survey noise. Some of the components of survey noise are noise caused by bouncing and motion of the sensor in the Earth’s field, noise caused by local geology, interference with sensor orientation or attitude sensors, noise caused by loose cables or connectors, noise due to metal worn or carried by the sensor operator, noise resulting from a tow vehicle and flexure in a sensor array, and noise resulting from external fields such as power distribution lines. System noise is measured by recording the sensor output as an operator surveys an area near the instrument verification strip that is known to be free of targets.



### **What is SNR and why is it important?**

In the context of this report the signal-to-noise ratio, or SNR, is the maximum signal compared to the root mean square (RMS) noise level. The SNR can be used to determine the expected detection performance of a geophysical sensor. In general, an SNR of 3 to 5 is required for reliable detection.

### **What if I do not have a sensor response curve for my item of interest?**

Approximate response curves for any object can be created using the software tool included with this report. A measurement of the response of the object in its minimum signal orientation at two depths is required. The tool then scales these measured responses to other depths using the known fall-off of signal with distance.

### **What should I do if during the removal action I find items that are smaller and deeper than the item of interest?**

This is one example where the assumptions in the Conceptual Site Model are found to be incorrect. This has no effect on the validity of the instrument verification strip and blind seed items for their intended purposes. It may require a re-evaluation of the anomaly selection criteria being used at the site. If the newly discovered items can be reliably identified using the anomaly selection criteria in place, no changes are required. If the size and depth distribution of the newly discovered items are such that they would not be reliably selected using the initial selection criteria, there are two choices. The first choice would be to establish a revised anomaly selection threshold that will result in detection of the newly discovered targets of interest and apply it retroactively to all geophysical data. If, however, the measured site noise precludes reliable detection of the new items to depth, either a different sensor will have to be chosen or the detection assumptions adjusted to reflect the capabilities of the sensor.

### **How does this process deal with partial rounds or components?**

Partial rounds or other components are just another target of interest and can be handled in the manner outlined in this approach. Their presence does not impact the need to verify sensor performance, only the anomaly selection criteria and how they are set. The site team first needs to determine what the targets of interest are. Then a sensor response curve can be generated for these items and an anomaly selection threshold established. Of course, it will not make sense to generate these curves for every conceivable munitions component. If this is the case, the anomaly selection criteria could be established in a more ad hoc way with the site noise data from this process used to quantify what level of signal could be reliably detected in the noise conditions of the site.

### **Is seeding required?**

Seeding is an integral part of the process and provides an ongoing (daily in the process outlined here) measure of the performance of the geophysical survey, data analysis, and anomaly resolution teams under the actual conditions of the site.

### **How do you decide what to seed?**

Seed items must be available, affordable, well characterized and, at least in some measure, representative of the items of interest at the site. This often means that the amplitude of the sensor signal expected and the anomaly footprint matches that of items of interest. The best choice will be ISOs, which are well characterized, inexpensive, and readily available.

### **Does the seeding have to be blind?**

To serve as an effective QC procedure, the seeding needs to be blind to the data collection, analysis, and anomaly resolution teams. The integrity of this process allows all stakeholders to have confidence in the result. The performer may choose to emplace some non-blind seeds for their own quality assurance (QA) purposes.

### **Can the performer's known QC items be used for any functions of this process?**

Yes, even items that are not blind seeded can provide information about position accuracy and performance of the geophysical survey system. These items do not, however, provide the assurance that all processing steps were performed correctly and the item was selected and placed on the dig list and correctly remediated, as does the use of blind seeds.

### **Will this work for "mag & flag"?**

The process as outlined in this document is not applicable to "mag & flag" surveys. The approach relies on the ability to demonstrate that a measured signal for a known object is consistent with physics-based model predictions and prior validating measurements, and further that the signal is detectable above measured site noise. Neither of these can be assured without a digital recording and subsequent analysis of the sensor output. Although some aspects of this approach may be transferable to projects based on analog technologies, it was not conceived with that approach in mind.

### **Do I need to prove I can detect an item to its required depth on this site?**

For the primary geophysical sensors used in munitions response projects, total-field magnetometers and time-domain EMI sensors, the response of the sensor to an item of interest can be predicted as a function of depth and orientation. Thus, the factor that limits the depth of detection of an item is the site survey noise. This noise can be measured at the instrument verification strip and confirmed in each survey data set. This allows ongoing confirmation of the detection limits for items of interest. This is not possible with a GPO. Of course, items can be seeded at depth if chosen by the site team but at a cost of noisy signals that will be difficult to use for quantitative comparisons.

### **So how do you set the anomaly selection criteria?**

In this document we highlight one method in which the sensor response curves are used to construct anomaly selection criteria that are tied to the targets of interest. Given that the minimum signal amplitude from each of the targets of interest can be predicted and verified with measurements, one would model the signal expected for each of the targets of interest

and set the threshold at the smallest sensor reading expected from the most stressing target of interest at its maximum depth of interest. Statistical fluctuations in measured signals can either be explicitly accounted for or a safety factor can be applied. The implication of this approach is that anomalies due to potential metal objects that are too low in amplitude to possibly be targets of interest are left off the dig list.

### **Why “industry standard objects?”**

It is often difficult and expensive to obtain enough inert versions of the items of interest to use as seeds. For nearly all munitions types, there are many configurations and no single, standard prototypical item exists. Even if they are available and within the project budget, use of inert munitions as seeds risks leaving one or more behind, leading to needless public alarm. Industry standard objects are convenient, inexpensive items that can easily be acquired in bulk and whose response to common geophysical sensors has been well characterized. In addition, the use of common seed items provides the ability to correlate results from different projects.

### **What do I need to do if I want to use something else in my instrument verification strip or seed program?**

The approach outlined here relies on the ability to demonstrate that a measured signal for the object is consistent with physics-based model predictions and prior validating measurements. Any item whose response can be modeled and for which a few confirmatory measurements can be made can be used in an instrument verification strip or seed program.

### **Who can model response curves?**

Although using the sensor response curves is straightforward, modeling sensor response curves from scratch, in particular those for an EM sensor, requires considerable effort and expertise. The software tool included with this report can be used to calculate an approximate EM61-MK2 response curve by scaling the results of a few measurements to the known fall-off with distance of EM signals. This difficulty is one of the stronger arguments for the use of ISOs—the curves for these items have already been calculated and validated by independent measurements.

### **Why does this process focus on the data rather than training and certifying survey teams?**

It is quality data that results in a quality survey product. It is assumed that the geophysical contractor will staff the survey with well-trained survey teams. This approach envisions a data-quality monitoring program to ensure that all data meet task order or project-specific quality requirements. The performance of these teams on the instrument verification strip and over the blind seeds will test that they are operating the equipment in a manner that results in quality data. Standard quality assurance quality controls are built into each project to help ensure quality data is generated.

**Will this process work for airborne or underwater surveys?**

The instrument verification strip is appropriate for all of these. If the goal of the survey is the detection of individual items, then most of the process as outlined here is applicable to the scenarios in question. The modeled response curves for airborne and underwater magnetometer systems are the same as those presented here. The response curves for EM systems operated underwater (particularly in salt water) may be shifted and will have to be calculated before use. If the airborne or underwater system is being used for wide area assessment (detection of areas of concentrated munitions use), then seeding may not be appropriate. Seeding in the underwater environment requires some effort to secure the seeds in a known location.

**Will this process work for transects?**

Yes, the process can work for transects but the seeding part may not be appropriate. The instrument verification strip would always be appropriate for confirming the proper operation of the geophysical sensor system. Seeding is more difficult with transects, but appropriate items could be placed on the surface just before the survey system passes. These would not be blind seeds but the response measured could be compared to expected response to give an ongoing measure of data validity.

**Can we have multiple instrument verification strips on a site if the site is large?**

Yes, multiple instrument verification strips make sense when the site is large. ESTCP has sponsored surveys for which IVSs were established at intermediate storage locations for the geophysical equipment. This placement facilitated the twice-daily survey of the IVS. If ISOs are the main constituents of the IVS, establishing multiple strips is not difficult.

Addendum To:

**GEOPHYSICAL SYSTEM VERIFICATION (GSV):  
A PHYSICS-BASED ALTERNATIVE TO GEOPHYSICAL PROVE-OUTS  
FOR MUNITIONS RESPONSE**

September 24, 2015

The original GSV process was designed at a time when the Geonics EM61-MK2 was the only electromagnetic induction sensor in general use. Since that time, a number of advanced EMI sensors [1-3] have become available and are starting to be used on munitions response projects, particularly in cued mode. All of the processes and procedures in GSV carry over to the advanced sensors with only one minor change.

The original report recommends the use of Industry Standard Objects as components of the IVS and for use as blind seeds in the production area. The ISOs specified at the time (Schedule 40 pipe nipples) were chosen to mimic the EM61 response of 37-mm projectiles, 60-mm mortars, and larger projectiles. As the industry gains experience with the advanced sensors, it has become clear that the original Schedule 40 ISOs (ISO40) are not as successful as surrogates to the new sensors. In addition, demonstrations have been conducted at sites with 20-mm projectiles; none of the original ISOs are good surrogates for 20-mm projectiles.

### 37-mm Projectile Surrogate

Figure A1 plots the principal-axis polarizability decays corresponding to a 37-mm projectile and the original small ISO40. The polarizability of the small ISO40 decays much faster at times beyond 1 ms. The latest gate in the EM61-MK2 is just after 1 ms so this was not observable with that sensor. During a demonstration at the former Camp Beale [4], a site with moderate geologic interference, the smaller polarizabilities of the small ISO40 at late times led to the ISO40 being more difficult to classify than the smallest munition of interest. This is not a desirable situation, as capturing all the ISO40 seeds required many extra clutter digs without increasing the efficiency of correctly classifying the munitions.

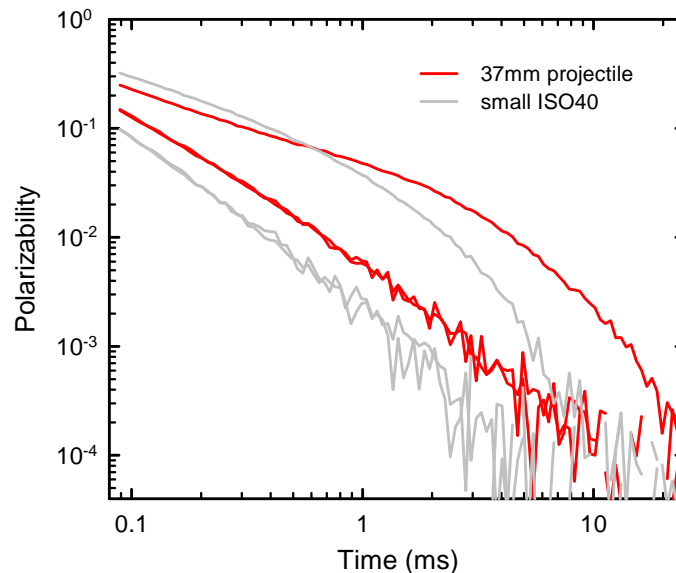

Figure A1 - Comparison of the derived polarizabilities for a 37-mm projectile and a small ISO40

Schedule 80 pipe nipples are a much better 37-mm projectile surrogate for the advanced sensors. Figure A2 plots the polarizabilities of a 1" (nominal) x 4" Schedule 80 pipe nipple (termed small ISO80). The late-time behavior is a much better match for the 37-mm projectile. All ESTCP demonstrations since 2014 have used this small ISO80 (McMaster-Carr P/N 4550K226) as the surrogate for 37-mm projectiles.

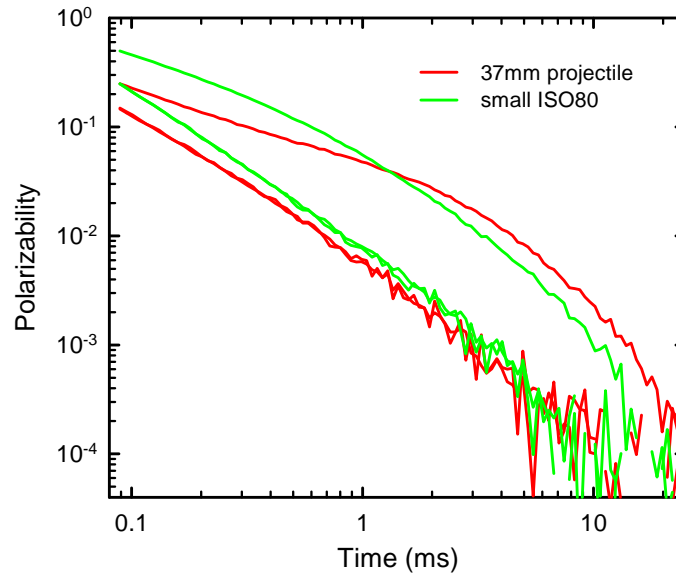

Figure A2 - Comparison of the derived polarizabilities for a 37-mm projectile and a small ISO80

### 20-mm Projectile Surrogate

In addition to the ISOs previously defined, a need has arisen for a surrogate for 20-mm projectiles. No readily-available pipe nipple has matching polarizabilities for the 20-mm projectiles we tested. Fortunately, we are able to identify a pair of inexpensive and readily available bolts that are good matches for the polarizabilities of a 20-mm projectile. The upper panel of Figure A3 plots the derived polarizabilities of a 5/8"-11 x 2" fully threaded bolt obtained from McMaster-Carr (Table A1) and a 20-mm projectile. The match is good overall but the polarizabilities of the bolt deviate somewhat in detail from the projectile. Advanced anomaly selection methods currently in use often use the total polarizability of unknown objects to make a size-based decision. The lower panel of Figure A3 compares the total polarizability of the 20-mm projectile and the bolt surrogate. The agreement here is almost perfect.

Table A1 - Details of two bolts found in this work to be good surrogates for 20-mm projectiles.

Potential Surrogate	Description	McMaster-Carr PN
1	Medium-Strength Grade 5 Zinc-Plated Steel Cap Screw, 5/8"-11 Fully Threaded, 2" Long	92865A802
2	Steel Heavy Hex Head Structural Bolt, 5/8"-11 Thread, 2" Long	91571A266

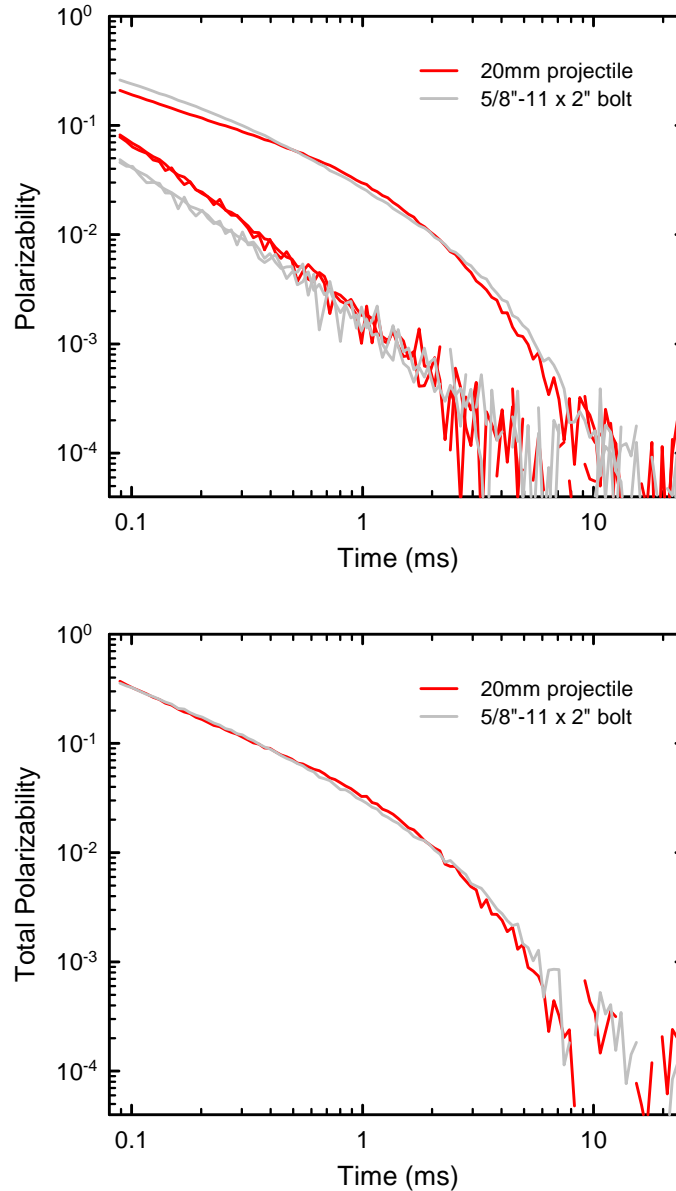

Figure A3 – Comparison of the derived individual polarizabilities (upper plot) and total polarizability (lower plot) for a 20-mm projectile and a 5/8"-11 x 2" bolt as described in the text.

## References

1. MetalMapper - <http://www.geometrics.com/geometrics-products/geometrics-electromagnetic-products/metal-mapper/>
2. TEMTADS 2x2 - <https://serdp-estcp.org/Program-Areas/Munitions-Response/Land/Sensors/MR-200807-MR-200909>
3. MPV - <https://serdp-estcp.org/Program-Areas/Munitions-Response/Land/Sensors/MR-201005/MR-201005>



4. “MetalMapper Demonstration at the Former Camp Beale, CA,” March 2012  
<https://serdp-estcp.org/content/download/14625/169527/version/1/file/Former+Camp+Beale+MetalMapper+Summary+Report.pdf>